

**3" ROUND & 4" OVAL SIDEBAR (90-DEG BENT END)  
09-13 DODGE RAM 1500 REGULAR CAB  
10-13 DODGE RAM 25-3500 REGULAR CAB  
(EXCLUDES VEHICLES W/DIESEL EXHAUST FLUID SYSTEMS)**

**PARTS LIST:**

Qty	Description	Qty	Description
1	Driver/Left Sidebar	4	1/2" X 1-1/2" OD x 1/8" flat washers
1	Passenger/Right Sidebar	4	12mm x 40mm Bolt/10mm Nut Plates
1	Driver/Left Front Mounting Bracket	2	12mm x 40mm Bolt Plates
1	Passenger/Right Front Mounting Bracket	6	12mm x 32mm OD x 3mm Flat Washers
1	Driver/Left Front Support Bracket	6	12mm Lock Washers
1	Passenger/Right Front Support Bracket	6	12mm Hex Nuts
1	Driver/Left Rear Mounting Bracket	6	12mm Plastic Retainers
1	Passenger/Right Rear Mounting Bracket	4	10-1.50mm x 35mm Hex Bolts
4	1/2" x 2" Hex Bolts	4	10mm x 30mm OD x 2.5mm flat washers
4	1/2" Lock Washers	4	10mm Lock Washers

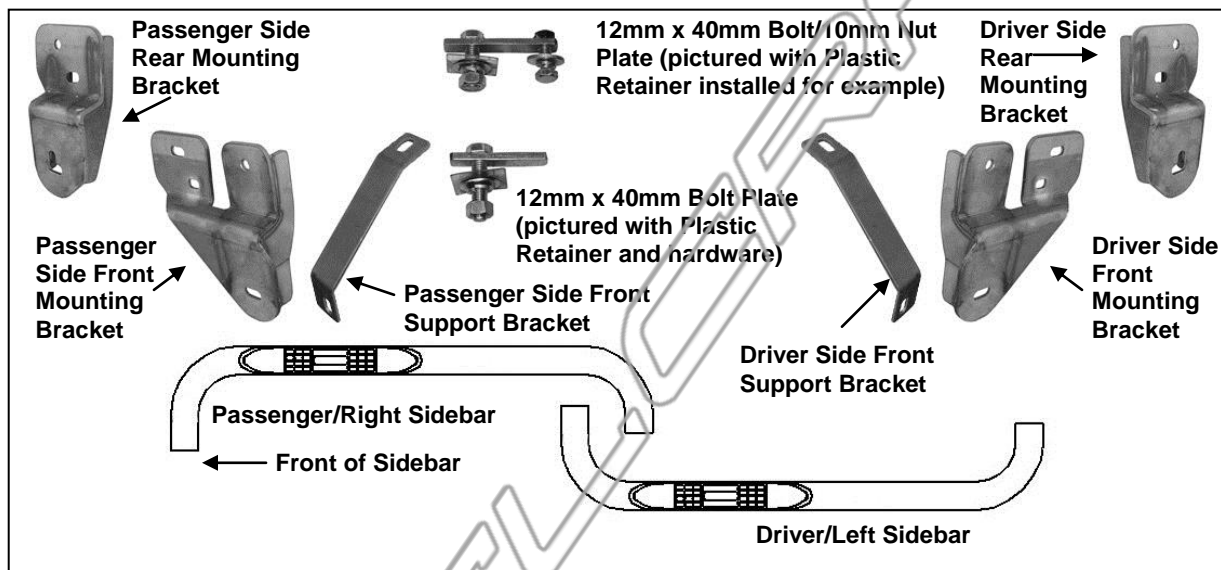

**PROCEDURE:**

- REMOVE CONTENTS FROM BOX. VERIFY ALL PARTS ARE PRESENT. READ INSTRUCTIONS CAREFULLY BEFORE STARTING INSTALLATION.**
- Starting at the passenger side-front of the vehicle, remove the tape covering the factory oval holes in the inner body panel located by the front tire.
- Select (1) 12mm Bolt Plate and partially thread a Plastic Retainer onto it, **(Fig 1A)**. Insert the Bolt Plate into the oval hole **(Fig 1B)**. Once the Bolt Plate is inserted, hold the Bolt end with one hand and tighten the Plastic Retainer with your other hand until it is tight against the body panel. **IMPORTANT:** The Plastic Retainer is designed to prevent the Bolt Plate from falling into the body cavity and to aid in installing the Mounting Bracket.
- Next, partially thread a Plastic Retainer onto the threaded end of a Bolt and Nut Plate, **(Fig 1C)**. Insert the Bolt and Nut Plate with Plastic Retainer into the factory oval hole, **(Figure 1B)**.
- Select the passenger side front Mounting Bracket. Position the Mounting Bracket onto the (2) Bolt Plates. Secure the Bracket to the Bolt Plates with (2) 12mm Flat Washers, (2) 12mm Lock Washers and (2) 12mm Hex Nuts, **(Figure 2)**. Do not tighten at this time. Rotate the Bolt and Nut plate until the threaded Nut end lines up with the remaining hole in the Mounting Bracket and body. Thread (1) 10mm x 35mm Hex Bolt, (1) 10mm Flat Washer and (1) 10mm Lock Washer into the threaded nut plate. Snug but do not tighten hardware at this time.

**3" ROUND & 4" OVAL SIDEBAR (90-DEG BENT END)  
09-13 DODGE RAM 1500 REGULAR CAB  
10-13 DODGE RAM 25-3500 REGULAR CAB  
(EXCLUDES VEHICLES W/DIESEL EXHAUST FLUID SYSTEMS)**

6. Remove the passenger side front factory body bolt. Select the passenger side Front Support Bracket. Insert the factory body bolt through the Support Bracket and up into its original position, **(Figure 2)**. Line the other end of the Support Bracket up with the oval hole in the Front Mounting Bracket. Snug but do not tighten hardware at this time.
7. Move to the passenger side rear of the vehicle and remove the tape covering the factory oval hole in the inner body panel as described in **Step 2**. Thread a Plastic Retainer onto the threaded end of a Bolt and Nut Plate, **(Figures 1C & 3)**. Insert the Bolt and Nut Plate into the factory hole, (see **Steps 3 & 4**).
8. Select the passenger side rear Mounting Bracket. Position the Mounting Bracket onto the installed Bolt and Nut Plate. Secure it with (1) 12mm Flat Washer, (1) 12mm Lock Washer and (1) 12mm Hex Nut, **(Figure 4)**. Do not tighten at this time. Rotate the Bolt and Nut plate until the threaded Nut end lines up with the remaining hole in the Mounting Bracket and body. Thread (1) 10mm x 35mm Hex Bolt, (1) 10mm Flat Washer and (1) 10mm Lock Washer into the threaded nut on the Bolt and Nut Plate. Snug but do not tighten hardware at this time.
9. Select the passenger Sidebar and fasten it to the front Mounting Bracket and Support Bracket with the included (1) 1/2" x 2" Hex Bolt, (1) 1/2" Lock Washer and (1) 1/2" Flat Washer, **(Figure 5)**. Do not tighten hardware at this time. Attach the Sidebar to the Rear Mounting Bracket with (1) 1/2" x 2" Hex Bolt, (1) 1/2" Lock Washer and (1) 1/2" Flat Washer, **(Figure 4)**.
10. Level and align Sidebar properly and tighten all hardware including the factory body bolt.
11. Repeat Steps 2-10 for driver Sidebar installation.
12. Do periodic inspections to the installation to make sure all hardware is secure and tight.

**To protect your investment**, wax this product after installing. Regular waxing is recommended to add a protective layer over the finish. Do not use any type of polish or wax that may contain abrasives that could damage the finish.

**For stainless steel:** Aluminum polish may be used to polish small scratches and scuffs on the finish. Mild soap may be used also to clean the Sidebar.

**For gloss black finishes:** Mild soap may be used to clean the Sidebar.

**PASSENGER SIDE INSTALLATION PICTURED**



**Fig 1A**

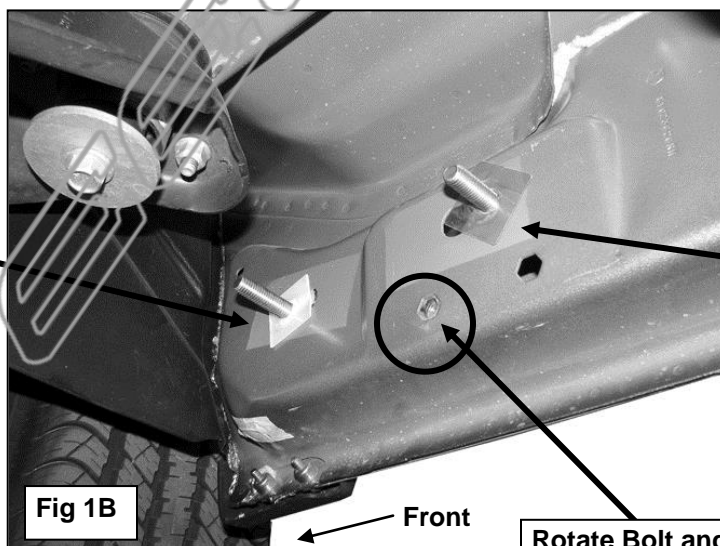

**Fig 1B**

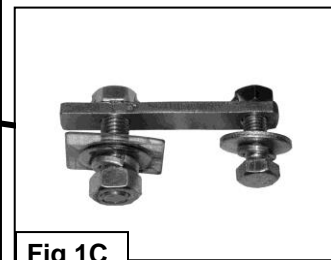

**Fig 1C**

**Rotate Bolt and Nut plate to line up Nut with this hole in body panel**

**3" ROUND & 4" OVAL SIDEBAR (90-DEG BENT END)  
 09-13 DODGE RAM 1500 REGULAR CAB  
 10-13 DODGE RAM 25-3500 REGULAR CAB  
 (EXCLUDES VEHICLES W/DIESEL EXHAUST FLUID SYSTEMS)  
 PASSENGER SIDE INSTALLATION PICTURED**

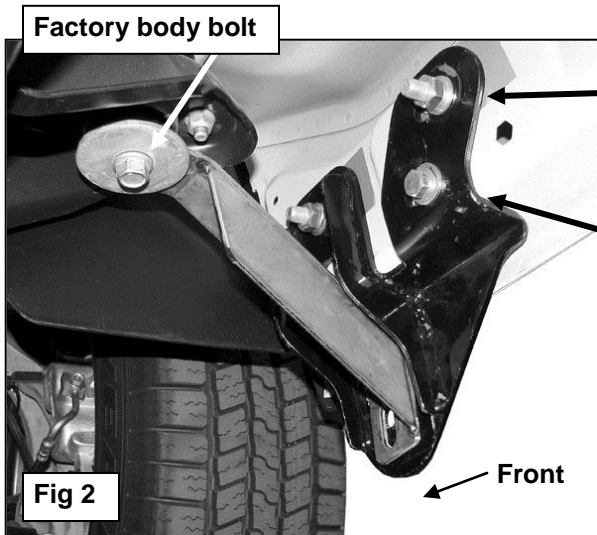

Factory body bolt

- (1) Bolt and Nut Plate
- (2) 12mm Hex Nut
- (2) 12mm Lock Washer
- (2) 12mm Flat Washer

- (1) 10mm x 35mm Hex Bolt
- (1) 10mm Lock Washer
- (1) 10mm Flat Washer

Fig 2

Front

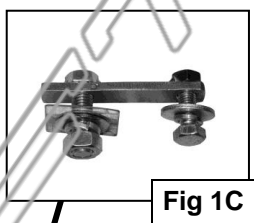
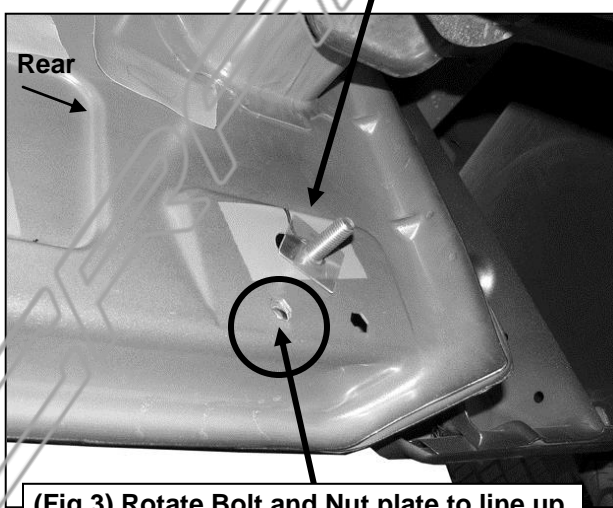
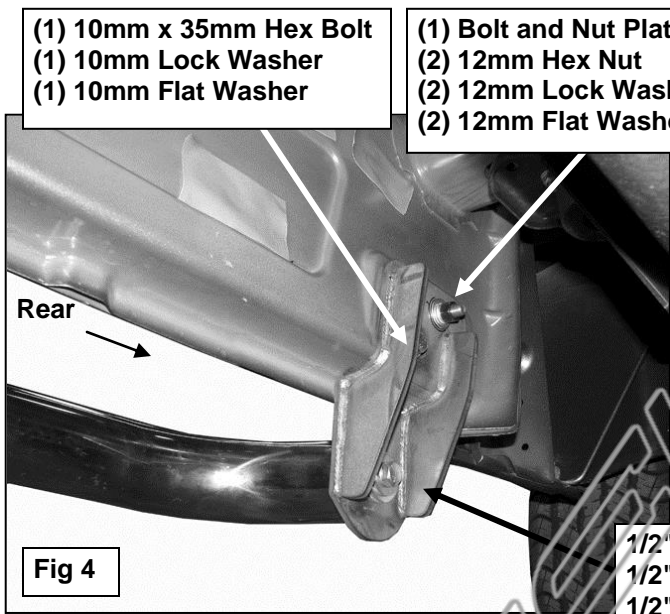

Fig 1C



(Fig 3) Rotate Bolt and Nut plate to line up the Nut with this hole in body panel



- (1) 10mm x 35mm Hex Bolt
- (1) 10mm Lock Washer
- (1) 10mm Flat Washer

- (1) Bolt and Nut Plate
- (2) 12mm Hex Nut
- (2) 12mm Lock Washer
- (2) 12mm Flat Washer

Rear

Fig 4

Factory body bolt

- 1/2" x 2" Hex Bolt
- 1/2" Flat Washer
- 1/2" Lock Washer

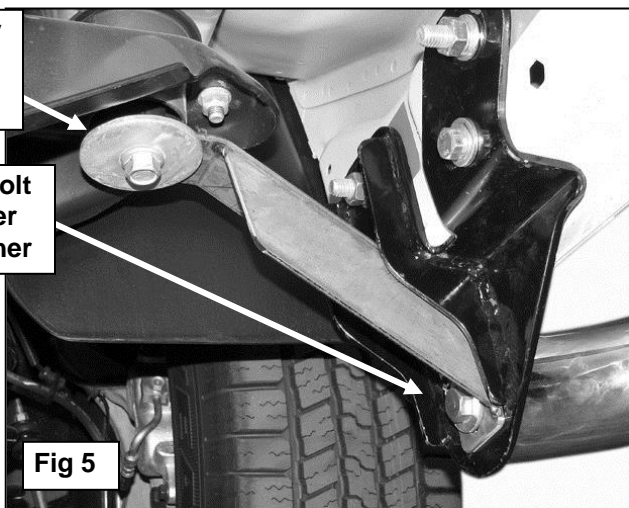
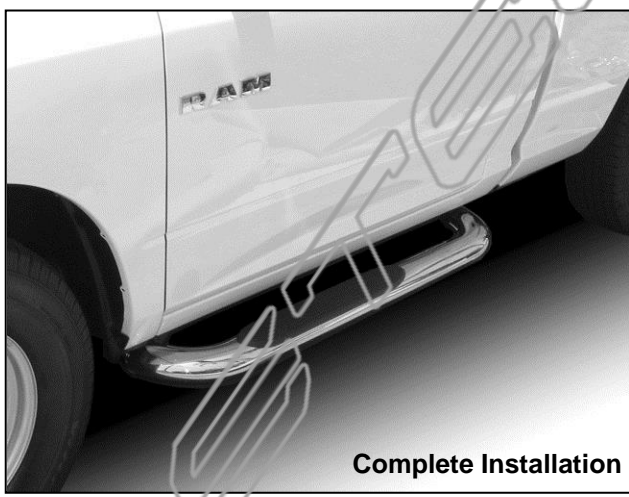

Fig 5



Complete Installation