

INSTALLATION INSTRUCTIONS

HD SIDE STEP

**07-17 1500-2500-3500 SILVERADO/SIERRA EXTRA/DOUBLE CAB
EXCLUDES 2017 MODELS W/DEF**

STEELCRAFT

PARTS LIST:

1	Driver side HD Side Step	11	8-1.25mm x 25mm Hex Bolts
1	Passenger side HD Side Step	1	8mm x 28mm x 3mm Flat Washer
1	Passenger side DEF Tank Upper Bracket	12	8mm x 24mm x 2mm Flat Washers
11	8-1.25mm Clip-On Nuts	12	8mm Lock Washers
1	8mm Bolt Plate	1	8-1.25mm Nylon Lock Nut
1	8-1.25mm x 40mm Hex Bolt		

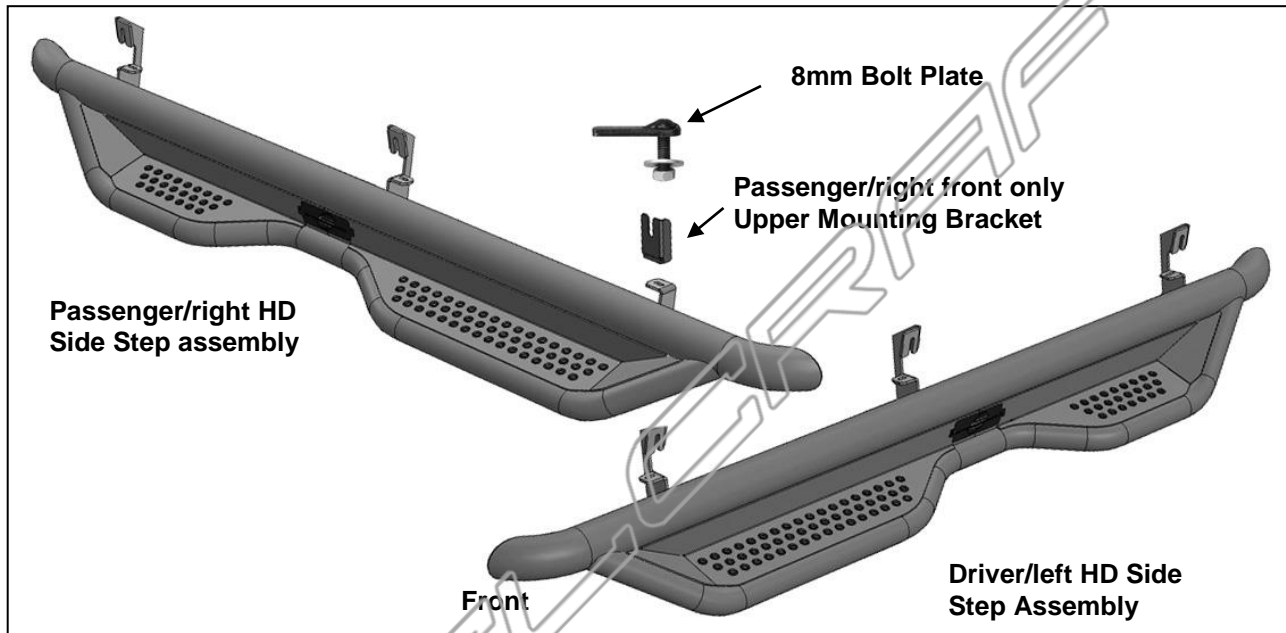

PROCEDURE:

REMOVE CONTENTS FROM BOX. VERIFY ALL PARTS ARE PRESENT. READ INSTRUCTIONS CAREFULLY BEFORE STARTING INSTALLATION. ASSISTANCE IS RECOMMENDED. ON MODELS WITH DEF TANK, SELECT A FLAT, LEVEL AREA FOR INSTALLATION.

1. Start the installation under the driver side of the vehicle. Locate the 4 tabs along the bottom edge of the body, (pinch weld). Mounting brackets on HD Side Step will attach to the 1st, 2nd and 4th mounting tabs, **(Figure 1)**. Directly above each tab is a top mounting location on the side of the body panel. If necessary, line up the driver/left HD Side Step with the mounting holes in the body panel to help determine correct locations.

2. Determine the correct procedure for your model year and each Bracket location.

Bottom mounting location on the edge of the pinch weld.

Flat tab on pinch weld with factory installed weld nut:

Thread hex bolt into weld nut from the backside-down to clear paint from threads, **(Figure 2)**.

Flat tab on pinch weld with hole:

Select (1) 8mm Clip Nut. Slide the Clip Nut over the tab with the nut facing up behind the tab, **(Figures 3—5)**. Line up threaded nut with hole in the tab. Repeat for each mounting location.

Locate top mounting location on the back side of the body panel.

Models with factory installed threaded insert in body panel:

Thread 8mm Hex Bolt into threaded insert to clear paint as required, **(Figures 2 & 3)**.

Large and small hole in side of body panel:

Remove the rubber plug from the larger hole, **(Figure 4)**. Select (1) 8mm Clip Nut. Slide the Clip Nut into the larger hole. Line up the threaded nut with the smaller hole, **(Figure 5)**.

3. With assistance, hold the HD Side Step up in position. Attach the mounting tabs on the HD Side Step to the Clip Nuts and/or the factory threaded holes with (6) 8mm Hex Bolts, (6) 8mm Lock Washers and (6) 8mm STD Flat Washers, **(Figures 6 & 7)**.
4. Level and adjust the HD Side Step and fully tighten all hardware.

5. Move to the passenger side of the vehicle. On the passenger side, determine if the vehicle is equipped with a plastic diesel exhaust fluid (DEF) tank, **(Figures 8 & 9)**.
Models without DEF tank, skip to Step 6.
Models with DEF tank: The tank sits close to the side of the body. With specialized tools, the passenger front upper and lower Bracket can be installed but room is limited. It may be easier to drop the tank down to access the inner side of the body panel for Upper Bracket installation. Tank will not need to be removed, only dropped down for access to mounting location. **IMPORTANT:** If tank is full, it will be very heavy and assistance is highly recommended to avoid injury or damage to the vehicle or the tank. It is recommended that installation is performed when the DEF tank is low on fluid before dropping the tank.
 - a. On models with plastic lower tray under the tank, remove the (3) hex bolts attaching the tray to the frame, **(Figure 8)**, and remove the tray.
 - b. Release the tank filler hose. Release the plug for the sending unit on the top of the tank.
 - c. Support the tank with a floor jack. Place a smooth flat surface, (wooden block for example), between the floor jack and the tank to avoid damaging the plastic tank. Do not push up on the tank; only support the weight of the tank with the jack.
 - d. Remove the (2) bolts securing the tank straps to the vehicle, **(Figure 9)**. Tilt the straps to release from the brackets. Slowly lower the tank until the top of the tank is almost visible. Use blocks or stands to support the tank while installing the front Upper Bracket.
6. Locate the first tab on the edge of the pinch weld, **(Figures 2—4, 11 & 12)**. Select the passenger/right front Upper Bracket, **(Figure 10)**. Repeat **Step 2** to attach the Upper Bracket first to the side of the body panel, **(Figure 11)**. Do not tighten hardware at this time.
7. Line up the hole in the bottom of the Upper Bracket with the hole in the tab on the pinch weld.
 - a. **Models with a weld-nut:** Slide the Bracket over the weld-nut, **(Figure 11)**. Insert (1) 8mm x 40mm Hex Bolt with (1) 8mm x 28mm Large Flat Washer down through the threaded hole in the weld nut and Upper Bracket, **(Figure 13)**. Tighten all hardware attaching the Upper Bracket only at this time.
 - b. **Models with flat tab and hole:** Select the 8mm Bolt Plate. Insert the Bolt Plate down through the hole in the Upper Bracket and the mounting tab, **(Figures 12 & 13)**. Leave loose at this time.
8. Repeat **Step 2** to prepare the center and rear mounting locations before installation, **(Figures 2—5)**.
9. With assistance, hold the HD Side Step up in position. Repeat **Step 3** to attach the HD Side Step to the passenger side center and rear mounting locations, **(Figures 6 & 7)**. Do not tighten hardware.
10. Line up the front mounting tab on the HD Side Step with the Upper Bracket. Attach the mounting tab to the Hex Bolt or Bolt-Plate in the bottom of the body panel with (1) 8mm x 24mm Flat Washer and (1) 8mm Nylon Lock Nut, **(Figure 13)**. Do not tighten hardware at this time.
11. Level and adjust the HD Side Step and fully tighten all hardware.
12. Once fully installed and all hardware fully tightened, reinstall the DEF tank and cover, if equipped, as described in **Step 5**.
13. Do periodic inspections to the installation to make sure that all hardware is secure and tight.

To protect your investment, wax this product after installing. Regular waxing is recommended to add a protective layer over the finish. Do not use any type of polish or wax that may contain abrasives that could damage the finish. Mild soap may be used to clean the HD Side Step.

Driver/Left Side Installation Pictured

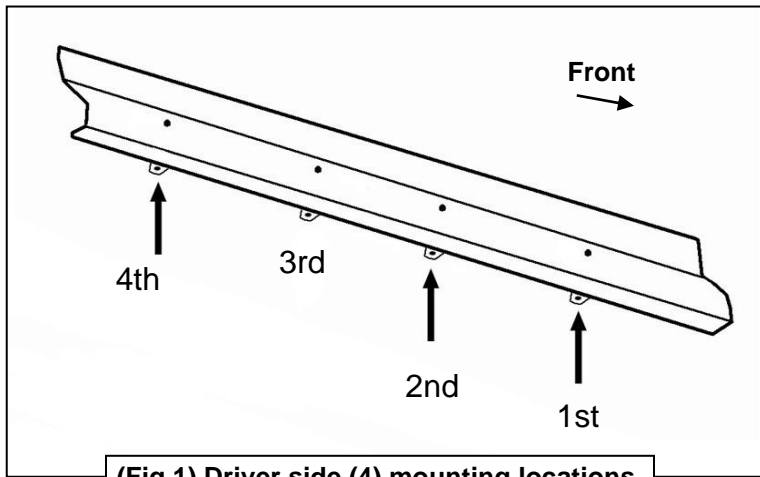

(Fig 1) Driver side (4) mounting locations

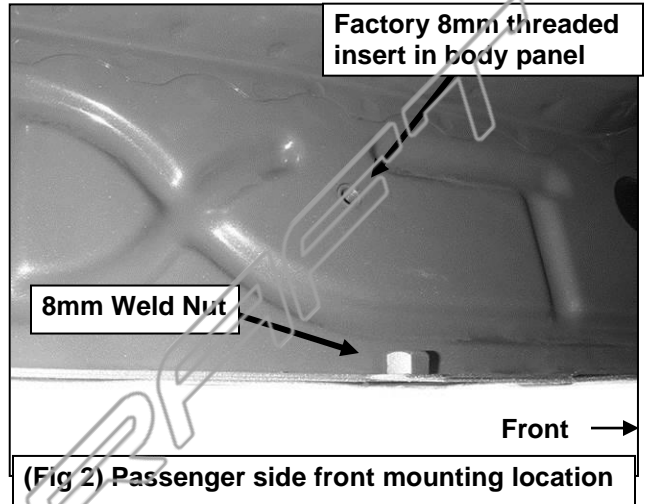

(Fig 2) Passenger side front mounting location

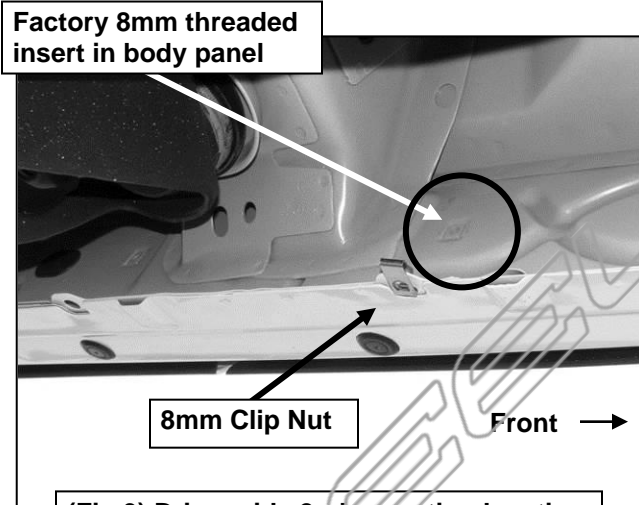

(Fig 3) Driver side 2nd mounting location

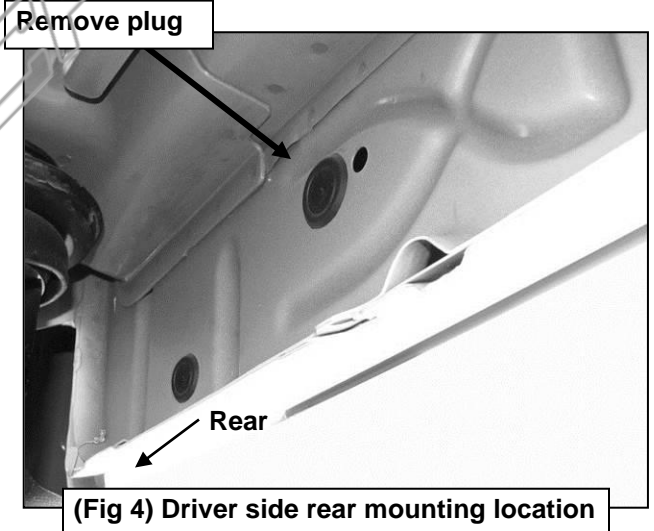

(Fig 4) Driver side rear mounting location

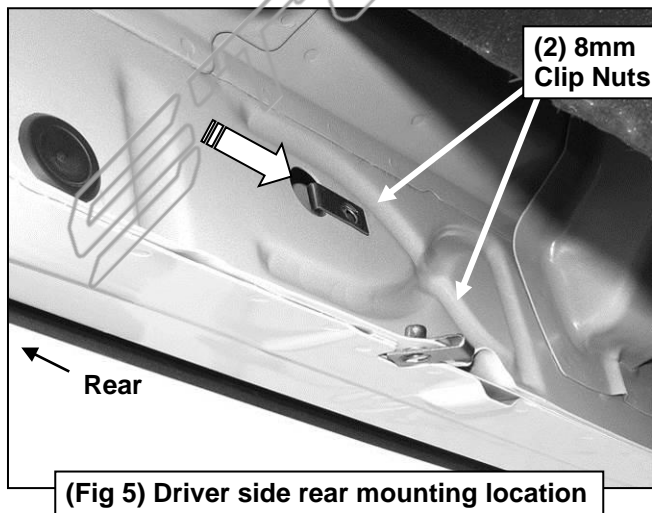

(Fig 5) Driver side rear mounting location

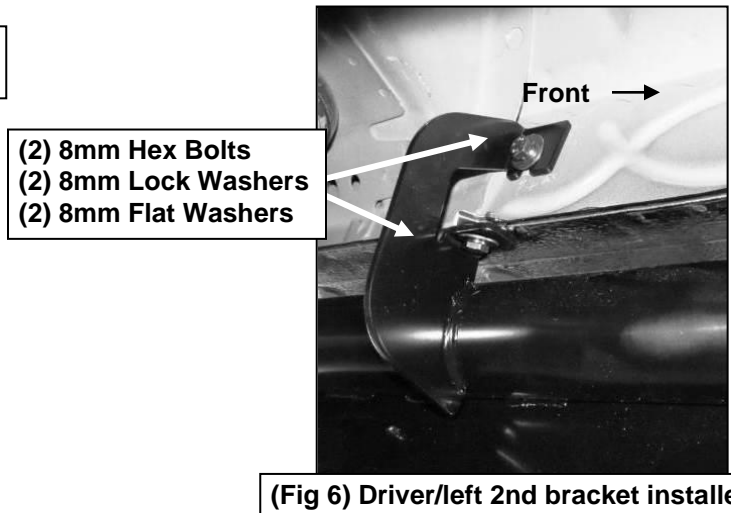

(Fig 6) Driver/left 2nd bracket installed

Driver/Left Side Installation Pictured

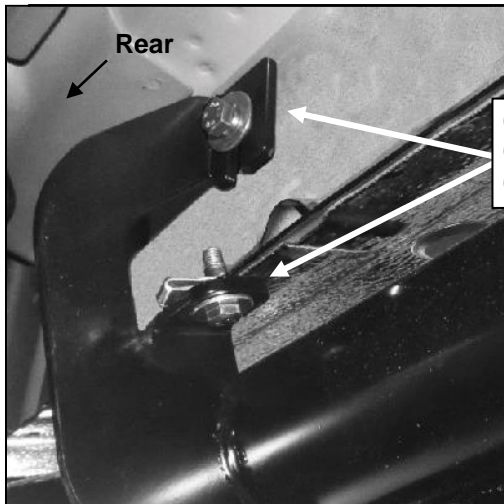

(Fig 7) Driver/left rear bracket installed

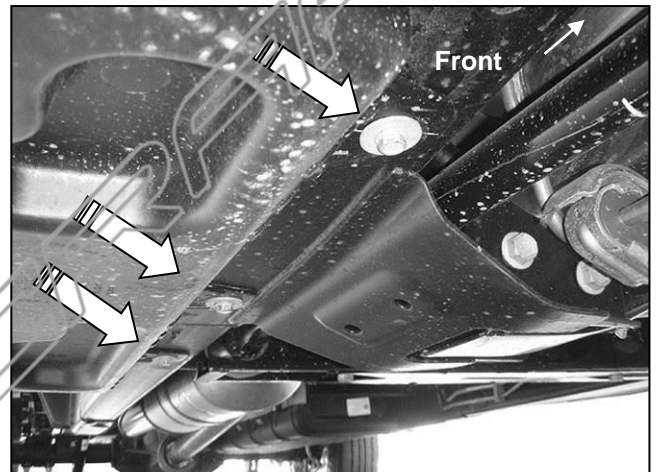

(Fig 8) Passenger side front pictured with DEF tank cover. Remove (3) hex bolts to remove cover

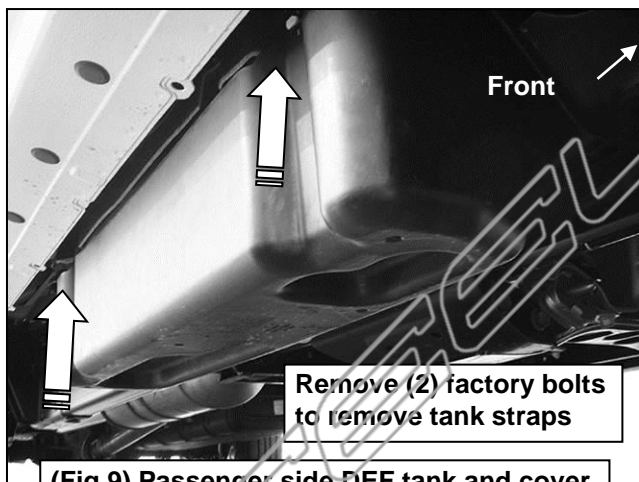

(Fig 9) Passenger side DEF tank and cover

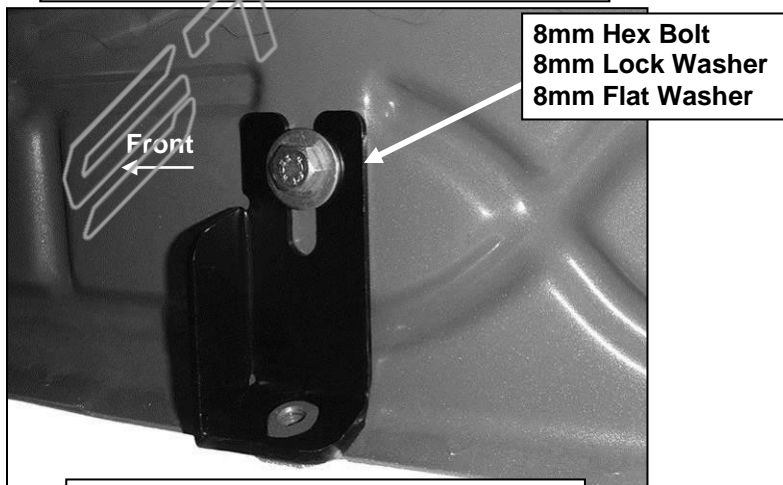

(Fig 11) Slide Upper Bracket over weld nut if equipped-also see Figure 2

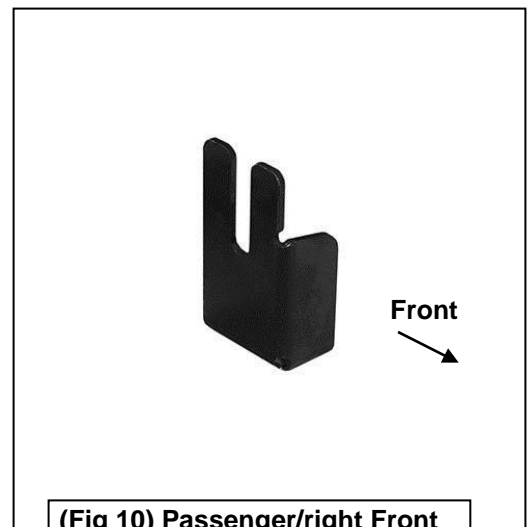

(Fig 10) Passenger/right Front Upper Bracket (all models)

Passenger/right Side Installation Pictured

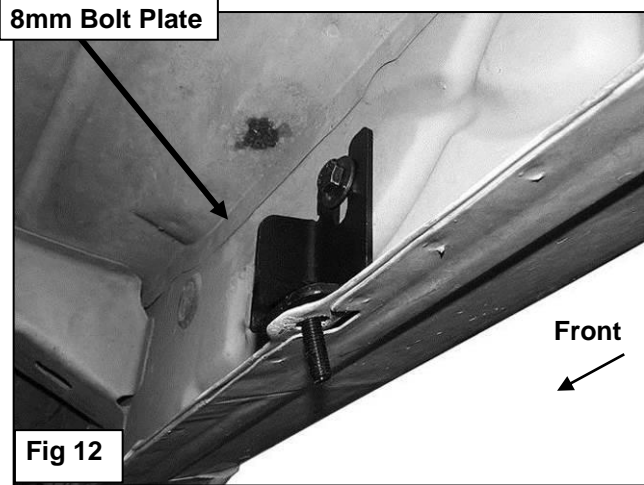

Models with flat tab on panel (see Fig 12):
8mm Bolt Plate

8mm Hex Bolt
8mm Lock Washer
8mm STD Flat Washer

