

**PARTS LIST:**

1	Driver/left Sidebar	4	1/2" x 2" Hex Bolts
1	Passenger/right Sidebar	4	1/2" x 1-1/4" OD x 3/32" Flat Washers
2	Driver side front-passenger side rear Sidebar Brackets	4	1/2" Lock Washers
2	Passenger side front-driver side rear Sidebar Brackets	2	8-1.25mm x 25mm Hex Bolts
2	Center Brackets (use for driver or passenger side)	20	8mm x 24mm OD x 2mm Washers
18	8mm Plastic Washers	2	8mm Lock Washers
		18	8-1.25mm Nylon Lock Nuts

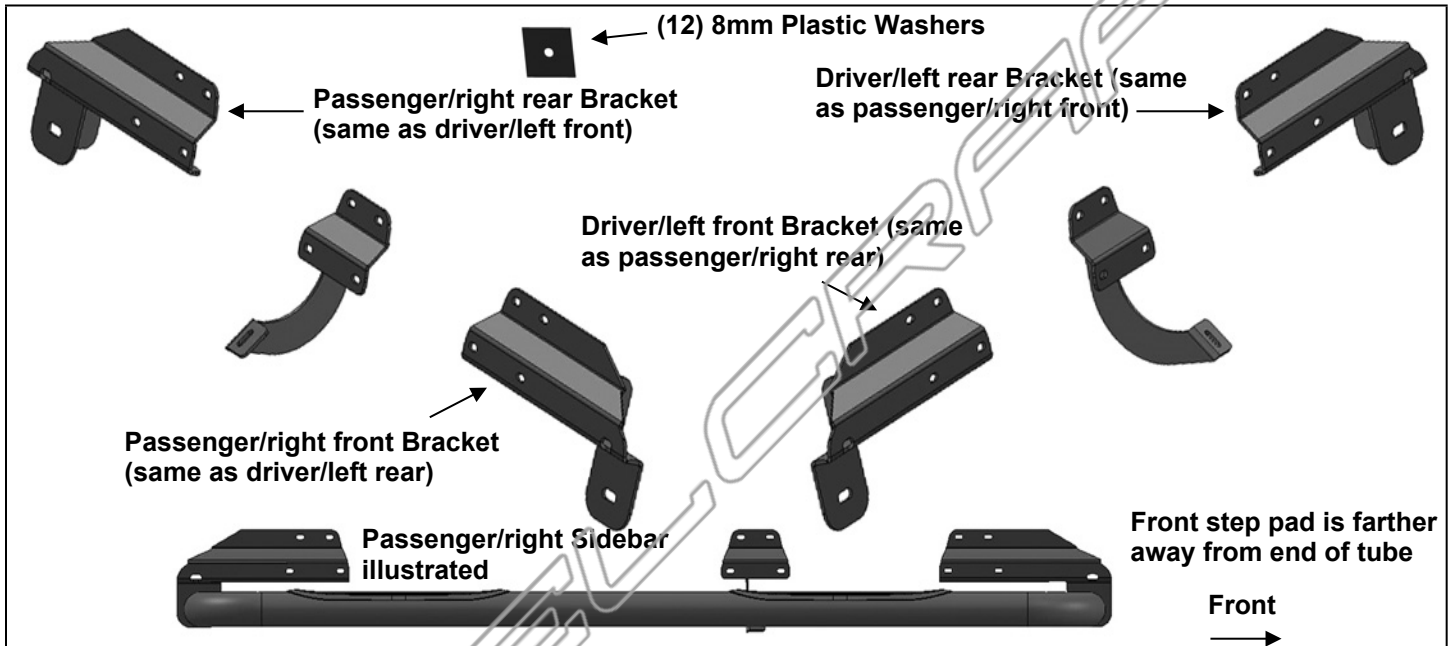

**PROCEDURE:**

**REMOVE CONTENTS FROM BOX. VERIFY ALL PARTS ARE PRESENT. READ INSTRUCTIONS CAREFULLY BEFORE STARTING INSTALLATION. ASSISTANCE IS RECOMMENDED.**

1. Start the installation under the driver side of the vehicle. Locate the front, center and rear factory running board mounting locations along the inner side of the body, **(Figure 1)**.
2. Slide (1) Plastic Washer over each factory mounting stud in the body panel, **(Figures 2 & 3)**. **IMPORTANT:** The Plastic Washers are designed to prevent corrosion between the aluminum body panel and the steel mounting brackets. **Do not install the Brackets without the Plastic Washers.**
3. Select (1) driver side front Mounting Bracket. **NOTE:** Same bracket is used for the passenger side rear installation. Attach the Mounting Bracket to the (3) factory studs with (3) 8mm Flat Washers and (3) 8mm Nylon Lock Nuts, **(Figure 4)**. Snug but do not fully tighten the hardware.
4. Select (1) Center Bracket. Repeat **Steps 1—3** to install the driver side center Bracket, **(Figure 5)**. **NOTE:** Center Bracket is the same, driver side and passenger side.
5. Repeat **Steps 1—3** to install the driver side rear Bracket, **(Figure 6)**. **NOTE:** Same Bracket is used for the passenger side front installation.
6. Select the driver/left Sidebar. With assistance, position the Sidebar up to the front and rear Mounting Brackets. Attach the Sidebar to the Mounting Brackets with the included (2) 1/2" x 2" Hex Bolts, (2) 1/2" Lock Washers, and (2) 1/2" Flat Washers, **(Figure 6)**. Leave hardware loose at this time.

7. Line up the threaded insert in the bottom of the Sidebar with the center Bracket. Attach the Sidebar to the Bracket with (1) 8mm x 25mm Hex Bolt, (1) 8mm Lock Washer and (1) 8mm Flat Washer, **(Figure 7)**. Leave hardware loose at this time.
8. Level and adjust the Sidebar and tighten all hardware.
9. Repeat **Steps 1—8** to install the passenger/right Sidebar.
10. Do periodic inspections to the installation to make sure that all hardware is secure and tight.

**To protect your investment**, wax this product after installing. Regular waxing is recommended to add a protective layer over the finish. Do not use any type of polish or wax that may contain abrasives that could damage the finish.

**For stainless steel:** Aluminum polish may be used to polish small scratches and scuffs on the finish. Mild soap may be used also to clean the Sidebar.

**For gloss black finishes:** Mild soap may be used to clean the Sidebar.

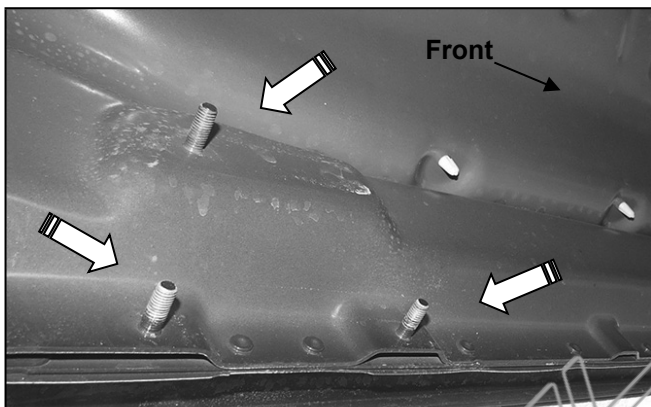

**(Fig 1) Locate the (3) factory threaded studs at each location. Driver side rear pictured**

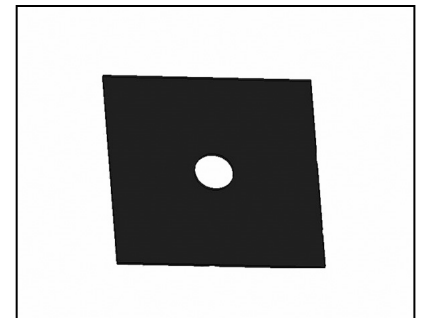

**(Fig 2) Plastic Insulation Washer**

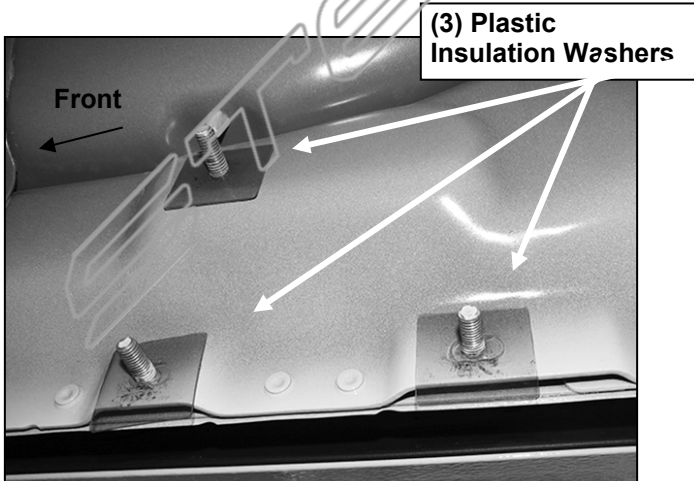

**(Fig 3) Thread Plastic Washers onto all mounting studs. Passenger side rear pictured**

Driver side installation pictured

(3) 8mm Flat Washers  
(3) 8mm Nylon Lock Nuts

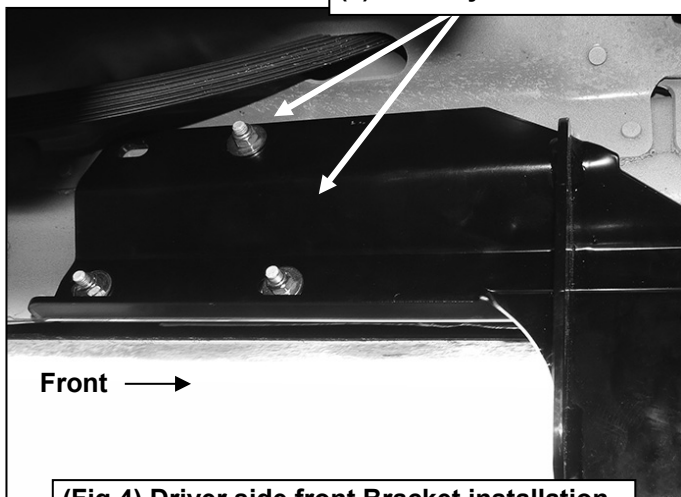

(Fig 4) Driver side front Bracket installation

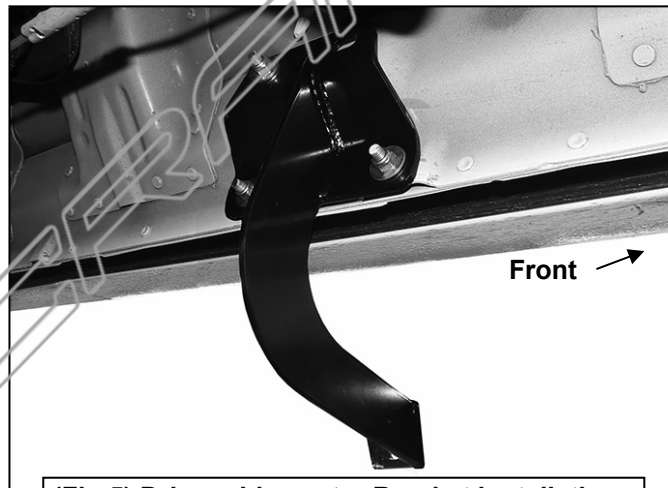

(Fig 5) Driver side center Bracket installation

1/2" x 2" Hex Bolts  
1/2" Flat Washers  
1/2" Lock Washers

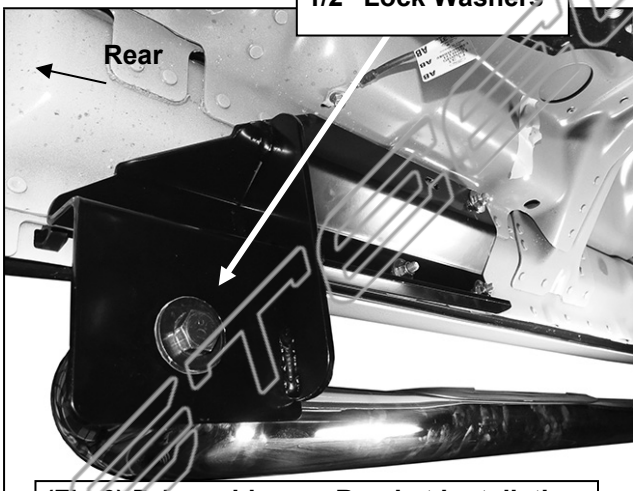

(Fig 6) Driver side rear Bracket installation

8mm x 25mm Hex Bolt  
8mm Lock Washer  
8mm Flat Washer

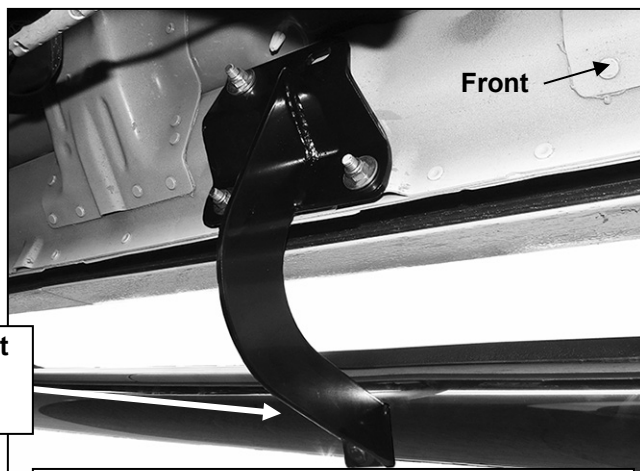

(Fig 7) Driver side center Bracket installation