

**5" OVAL WHEEL TO WHEEL SIDE BAR
2001-14 25-3500 SILVERADO/SIERRA CREW CAB W/6-1/2Ft BED**

PARTS LIST:

1	Driver/Left Side Bar	2	10mm Button Head Bolt Plates
1	Passenger/Right Side Bar	4	10-1.50mm x 30mm Hex Bolts
1	Driver/Left Front Mounting Bracket	10	10mm x 20mm OD x 2mm Flat Washers
1	Passenger/Right Front Mounting Bracket	6	10mm Lock Washers
1	Driver/Left Side Center Mounting Bracket	6	10mm Hex Nuts
1	Passenger/Right Side Center Mounting Bracket	2	10mm Plastic Retainers
1	Driver/Left Rear Mounting Bracket	2	8mm Button Head Bolt Plates
1	Passenger/Right Rear Mounting Bracket	12	8-1.25mm x 25mm Hex Bolts
1	Driver/Left Front Support Bracket	14	8mm ID x 24mm OD x 2mm Flat Washers
1	Passenger/Right Front Support Bracket	14	8mm Lock Washers
1	Driver/Left Rear Support Bracket	2	8mm Hex Nuts
1	Passenger/Right Rear Support Bracket		

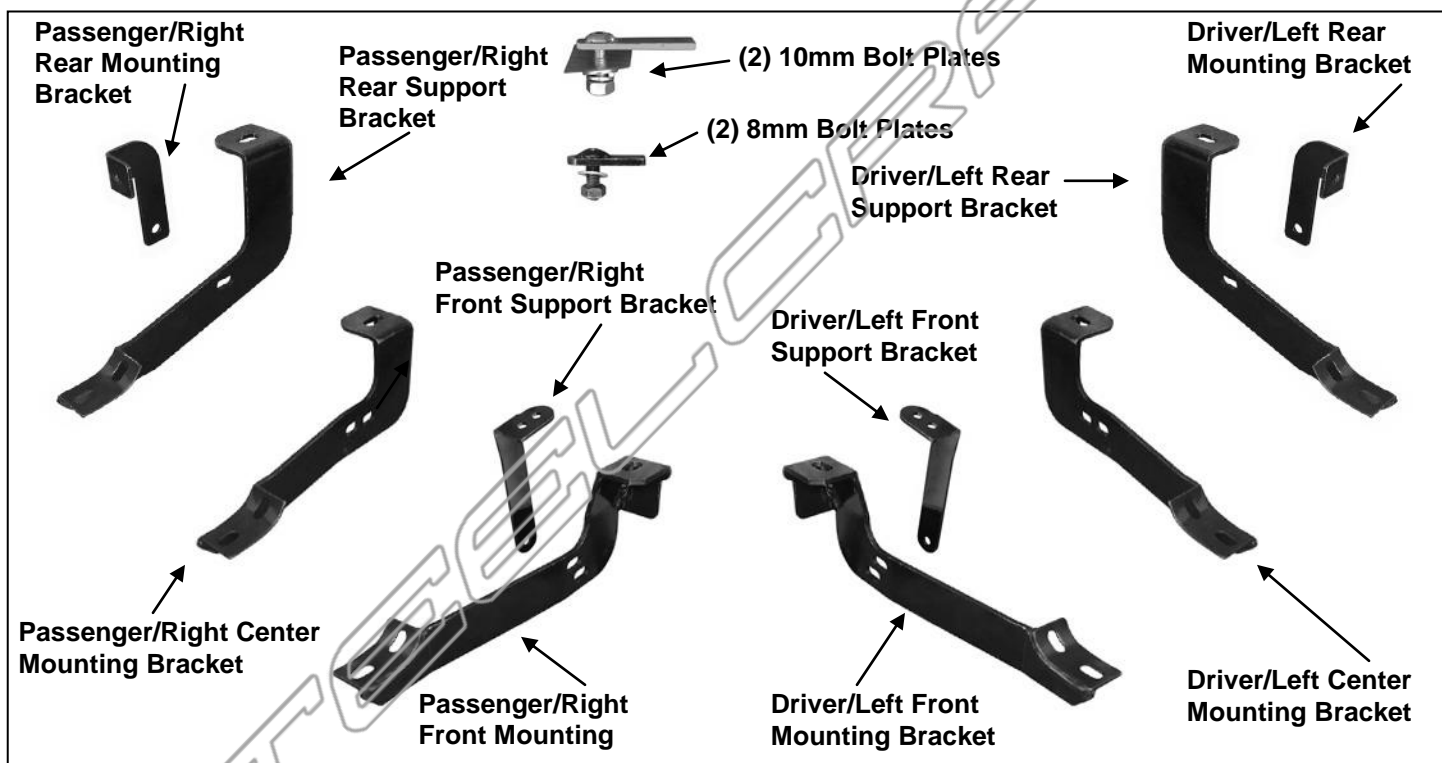

PROCEDURE:

REMOVE CONTENTS FROM BOX. VERIFY ALL PARTS ARE PRESENT. READ FACTORY BODY BOLT REMOVAL INSTRUCTIONS AND INSTALLATION INSTRUCTIONS CAREFULLY BEFORE STARTING INSTALLATION.

1. Start the installation under the driver side of the vehicle and remove the front body mount bolt. Do not remove the rubber bushing.
2. Hang the driver side front Mounting Bracket from the body mount using the factory hex bolt, **(Figure 1)**. Do not tighten hardware at this time.
3. Locate the factory hole in the bottom of the floor panel next to the front body mount, **(Figure 2)**. Select (1) 8mm Bolt Plate. Insert the Bolt Plate into the hole, **(Figures 3A & 3B)**. Attach the driver side front Support Bracket to the Bolt Plate with (1) 8mm Lock Washer, (1) 8mm Flat Washer and (1) 8mm Hex Nut, **(Figure 4)**. **IMPORTANT:** Rotate Bolt Plate 90-degrees to the direction of the slot, **(Figure 3A)**. Bolt the lower end of the Support Bracket to the back of the Front Bracket with (1) 10mm x 30mm Hex Bolt, (2) 10mm Flat Washers, (1) 10mm Lock Washer and (1) 10mm Hex Nut, **(Figure 4)**. Do not tighten hardware.

**5" OVAL WHEEL TO WHEEL SIDE BAR
2001-14 25-3500 SILVERADO/SIERRA CREW CAB W/6-1/2ft BED**

4. Select the Center Mounting Bracket and bolt it in place with the factory body bolt as described in Step 2, **(Figure 5)**. Do not tighten at this time. **NOTE:** The Center Bracket has (2) extra slots that will not be used for this installation.
5. Move to the rear body mount location. Install the rear Mounting Bracket as previously described in Steps 2 & 4, **(Figure 6)**. Locate the factory hole in the side of the body panel towards the rear of the vehicle. Remove the rubber plug, **(Figure 7)**. Thread (1) 10mm Plastic Retainer part way onto (1) 10mm Bolt Plate, **(Figures 8A & 8B)**. Insert the Bolt Plate into the hole and thread the Plastic Retainer down until it is tight against the body panel, **(Figure 8A)**. **IMPORTANT:** The Plastic Retainer is designed to prevent the Bolt Plate from falling into the body cavity and to aid in installing the Support Bracket.
6. Attach the driver side rear Support Bracket, **(Figure 9)**, to the Bolt Plate with (1) 10mm Lock Washer, (1) 10mm Flat Washer and (1) 10mm Hex Nut. Bolt the lower end of the Support Bracket to the back of the Rear Bracket with (1) 10mm x 30mm Hex Bolt, (2) 10mm Flat Washers, (1) 10mm Lock Washer and (1) 10mm Hex Nut, **(Figure 10)**. Do not tighten hardware at this time.
7. Carefully position the Driver Sidebar onto the Mounting Brackets. Attach the Sidebar to the Mounting Brackets with (6) 8mm x 25mm Hex Bolts, (6) 8mm Lock Washers and (6) 8mm Flat Washers, **(Figure 11)**. Do not tighten hardware at this time.
8. Level and adjust the Sidebar and tighten all hardware.
9. Repeat **Steps 2 - 8** for passenger Sidebar installation.
10. Do periodic inspections to the installation to make sure that all hardware is secure and tight.

To protect your investment, wax this product after installing. Regular waxing is recommended to add a protective layer over the finish. Do not use any type of polish or wax that may contain abrasives that could damage the finish.

For stainless steel: Aluminum polish may be used to polish small scratches and scuffs on the finish. Mild soap may be used also to clean the Sidebar.

For gloss black finishes: Mild soap may be used to clean the Sidebar.

Driver Side Installation Pictured

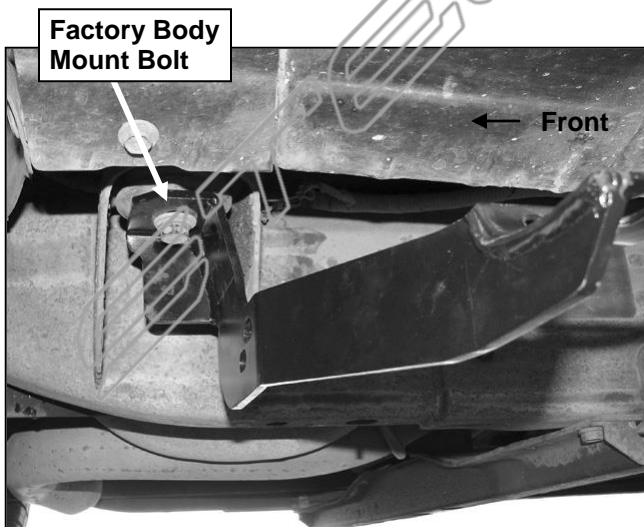

(Fig 1) Driver side front mounting bracket pictured

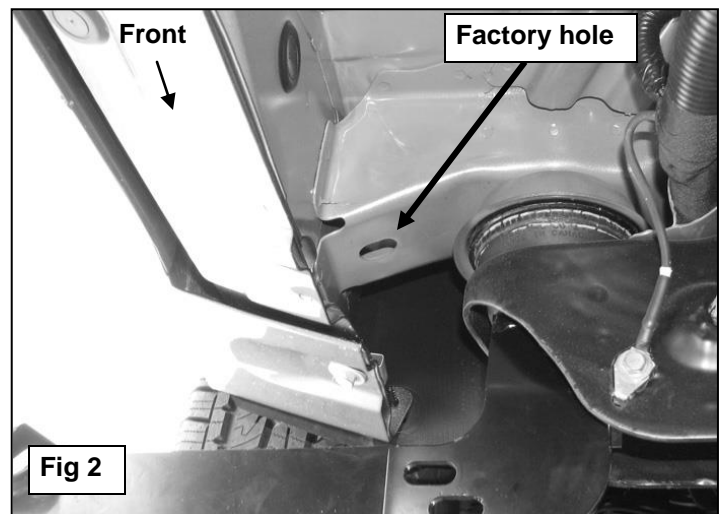
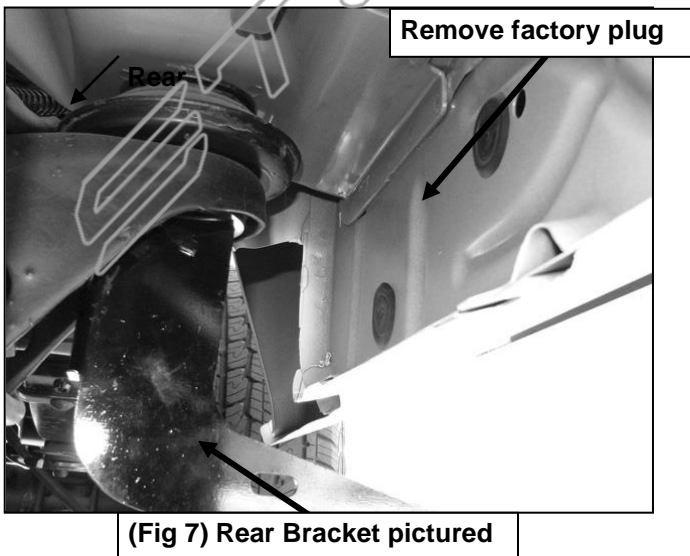
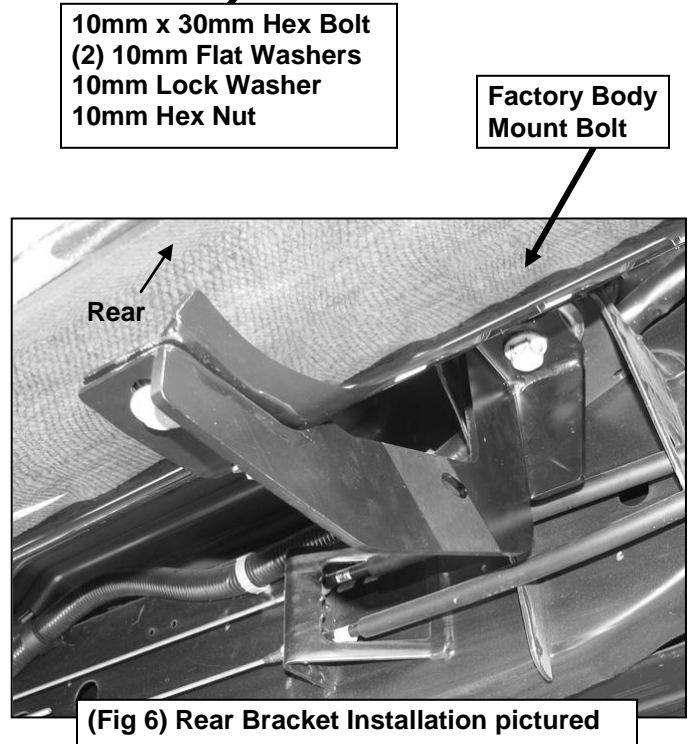
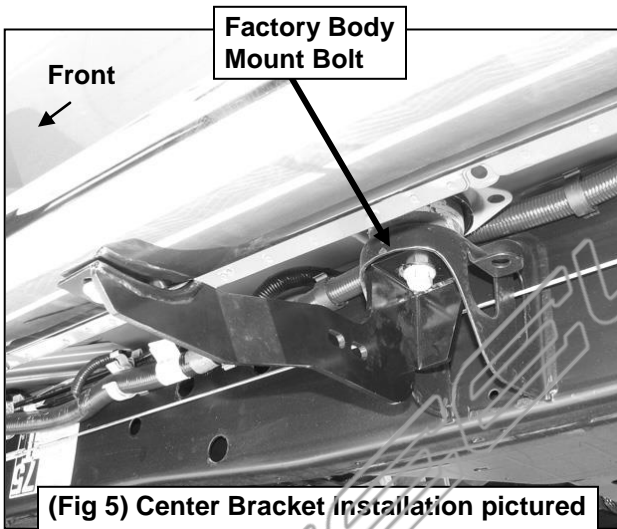
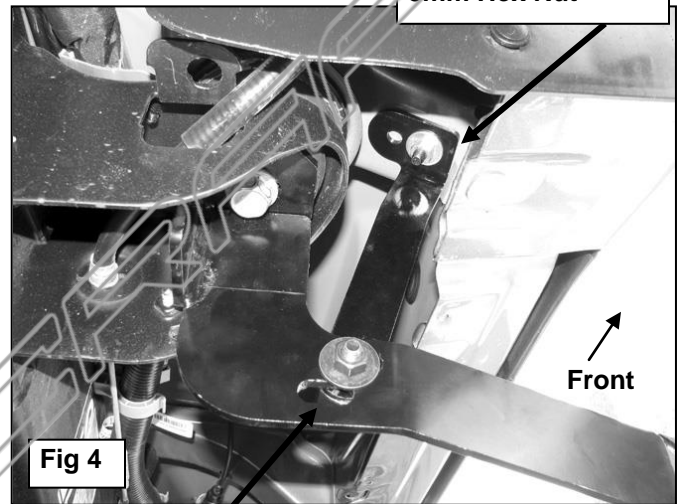
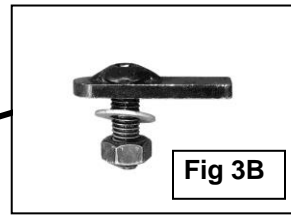
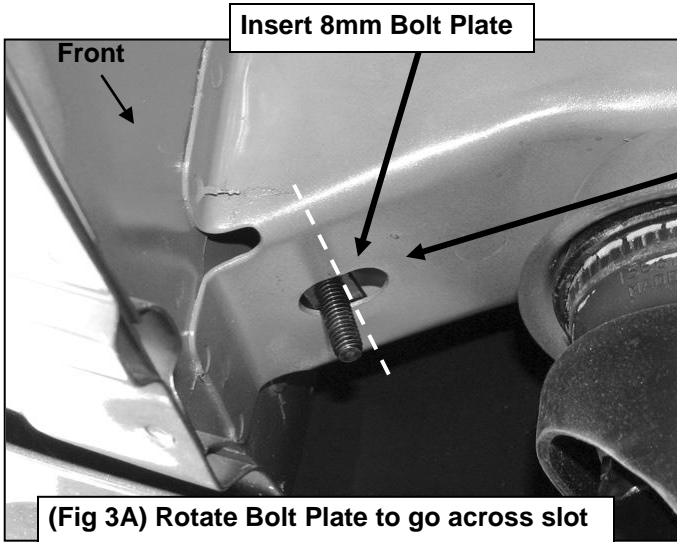
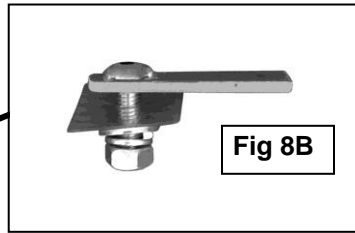
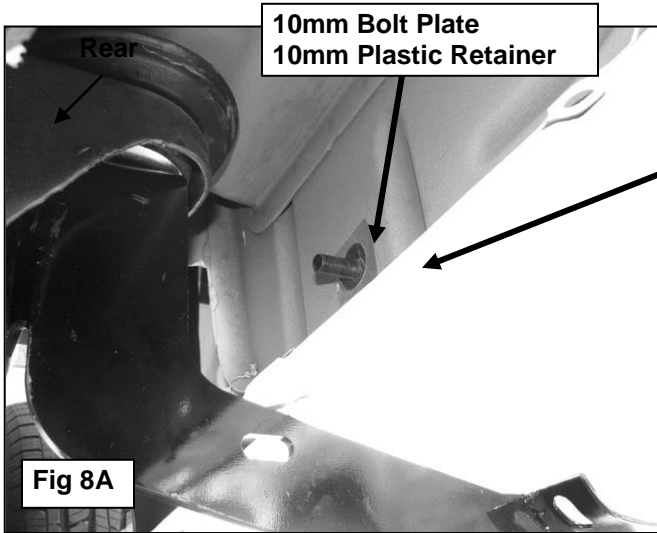

Fig 2

**5" OVAL WHEEL TO WHEEL SIDE BAR
2001-14 25-3500 SILVERADO/SIERRA CREW CAB W/6-1/2Ft BED
Driver Side Installation Pictured**



**5" OVAL WHEEL TO WHEEL SIDE BAR
2001-14 25-3500 SILVERADO/SIERRA CREW CAB W/6-1/2Ft BED
Driver Side Installation Pictured**



- 10mm Bolt Plate
- 10mm Plastic Retainer
- 10mm Lock Washer
- 10mm Flat Washer
- 10mm Hex Nut

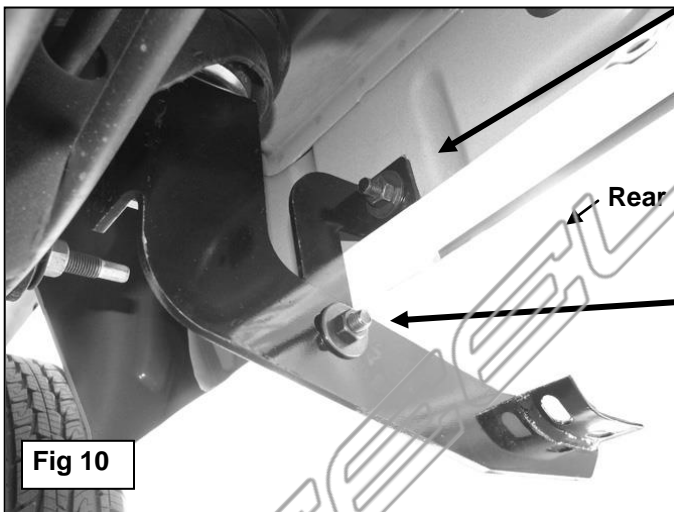

- 10mm x 30mm Hex Bolt
- (2) 10mm Flat Washers
- 10mm Lock Washer
- 10mm Hex Nut

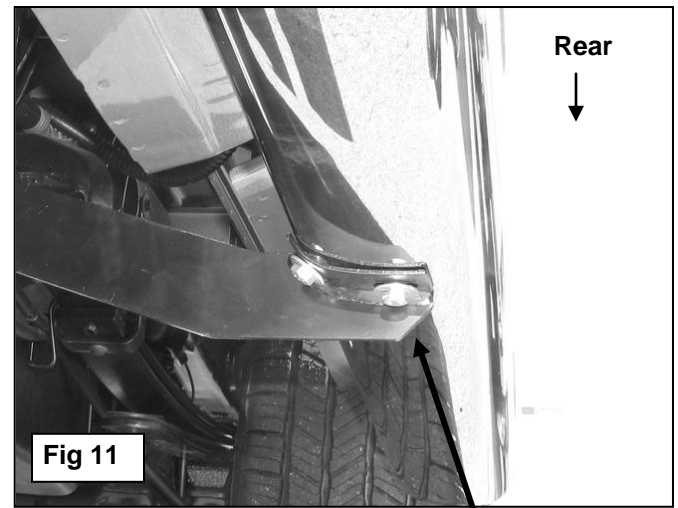

- (2) 8mm x 25mm Hex Bolts
- (2) 8mm Lock Washers
- (2) 8mm Flat Washers

