

**PARTS LIST:**

1	Driver/left Side Rattler Running Board (85in)	16	8mm x 24mm x 2mm Flat Washers
1	Passenger/right side rattler Running Board (85in)	8	6mm x 30mm Double Bolt Plates
8	Mounting Brackets	16	6mm x 22mm x 2mm Flat Washers
16	8-1.25mm x 30mm Hex Bolts	16	6mm Lock Washers
16	8mm Lock Washers	16	6mm Hex Nuts

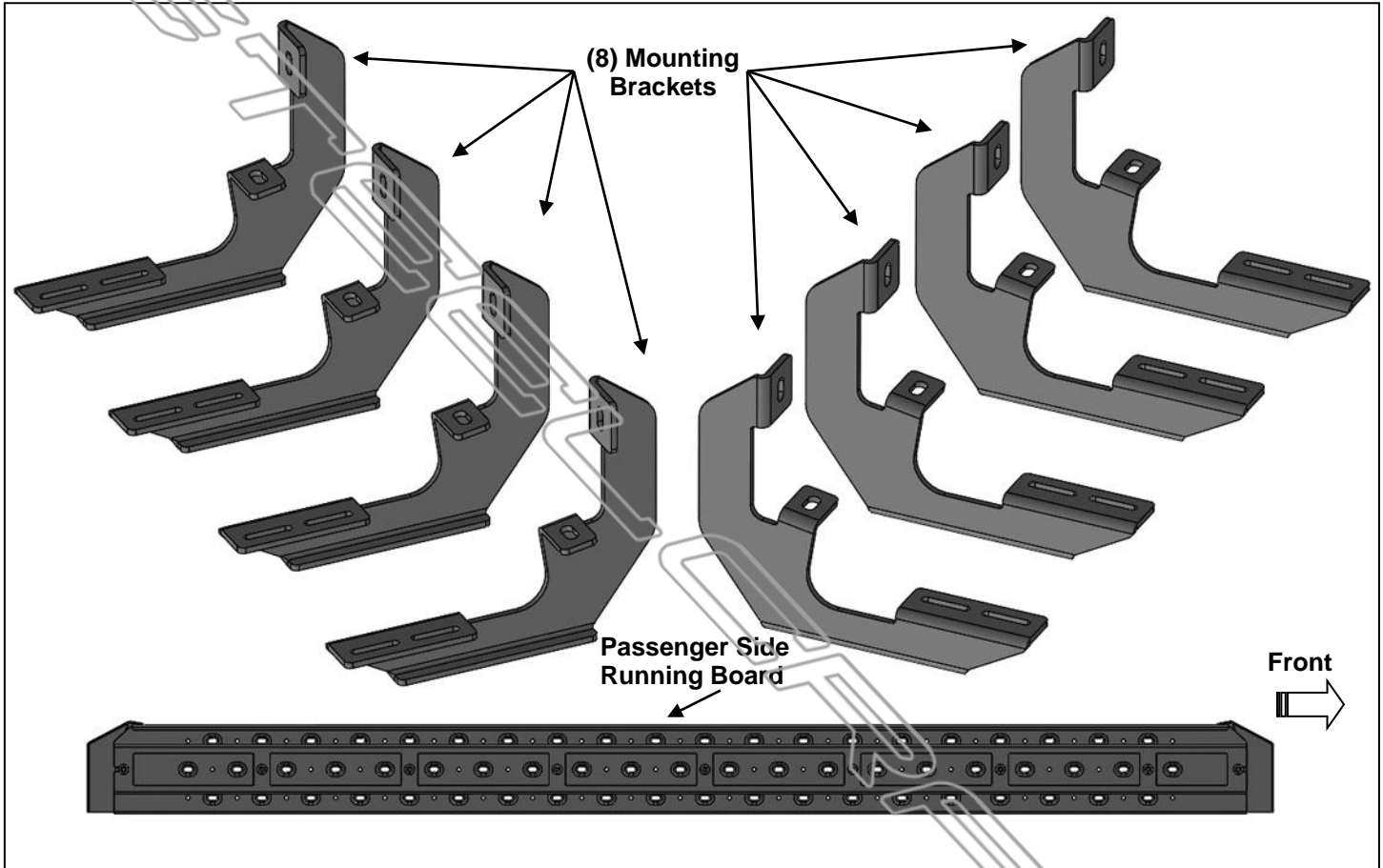

**PROCEDURE:**

**REMOVE CONTENTS FROM BOX. VERIFY ALL PARTS ARE PRESENT. READ INSTRUCTIONS CAREFULLY BEFORE STARTING INSTALLATION. ASSISTANCE IS RECOMMENDED.**

1. Start the installation under the driver side of the vehicle. Locate the 6 plugs along the bottom edge of the body. Mounting Brackets will bolt to the 1st, 3rd, 4th and 6th threaded mounting holes, **(Figures 1—5)**. Remove the plastic plugs from each mounting location. Directly above each threaded insert is a top mounting location on the side of the body panel. Hold a Bracket up in place to help determine the mounting holes to use along the body. **NOTE:** Thread an 8mm Hex Bolt into the threaded inserts to clear paint as required.
2. Select (1) Mounting Bracket. Starting at the front of the driver/left side, bolt the Mounting Bracket to the factory threaded holes with (2) 8mm Hex Bolts, (2) 8mm Lock Washers and (2) 8mm Flat Washers, **(Figures 6 & 7)**. Do not tighten hardware at this time.
3. Repeat **Steps 1 & 2** to install (3) Mounting Brackets on the remaining driver/left side mounting locations along the body panel, **(Figures 8—10)**.
4. Select the Driver/left side Running Board. Use the illustration above to help determine the correct Sidebar. Place the Running Board on top of the Brackets. **IMPORTANT:** Do not slide, (front to back or

rotate), the Running Board on the Brackets or damage to the finish may result. Locate the channel opening in the bottom of the Running Board. Select (4) 6mm Double Bolt Plates. Insert the Bolt Plates into the channel in the bottom of the Running Board closest to the Brackets, **(Figure 11)**. Lift the Running Board up and guide the studs through the Brackets.

5. Attach the Running Board to the Brackets with (8) 6mm Flat Washers, (8) 6mm Lock Washers and (8) 6mm Hex Nuts, **(Figures 12—15)**.
6. Level and adjust the Running Board and fully tighten all hardware.
7. Repeat **Steps 1—6** for Driver/left side Running Board Installation.
8. Do periodic inspections to the installation to make sure that all hardware is secure and tight.

**To protect your investment**, wax this product after installing. Regular waxing is recommended to add a protective layer over the finish. Do not use any type of polish or wax that may contain abrasives that could damage the finish. Aluminum polish may be used to polish small scratches and scuffs on the finish. Mild soap may be used also to clean the Running Board.

### Passenger/right side Installation Pictured

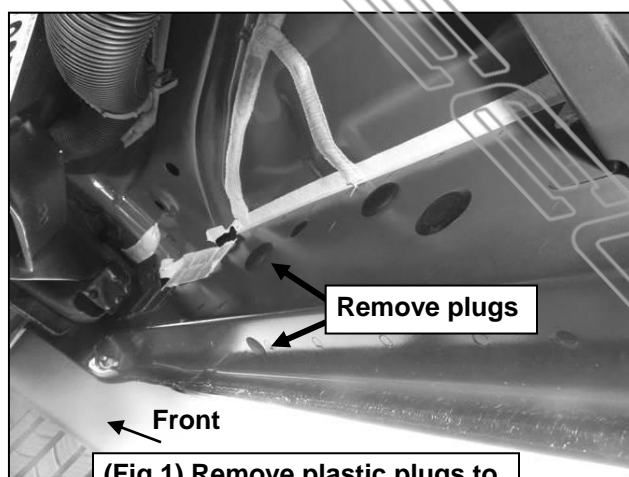

**(Fig 1) Remove plastic plugs to uncover threaded inserts**

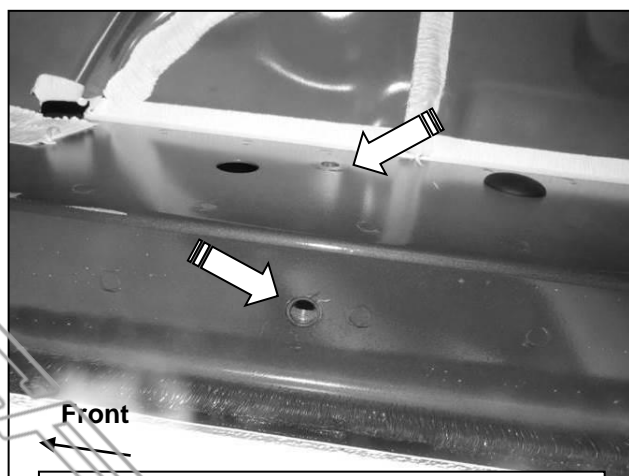

**(Fig 2) Passenger front mounting location**

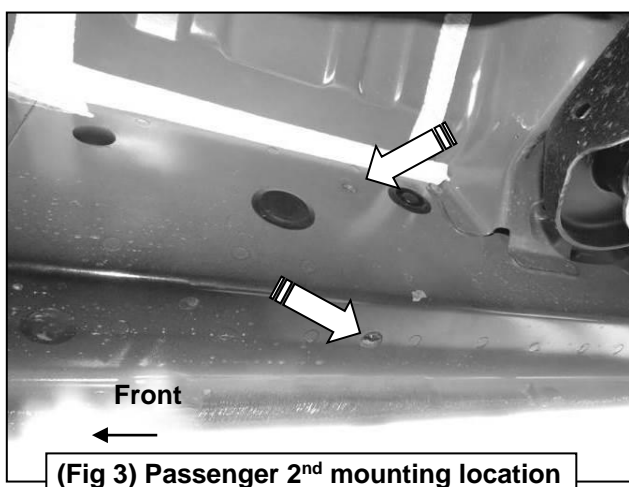

**(Fig 3) Passenger 2<sup>nd</sup> mounting location**

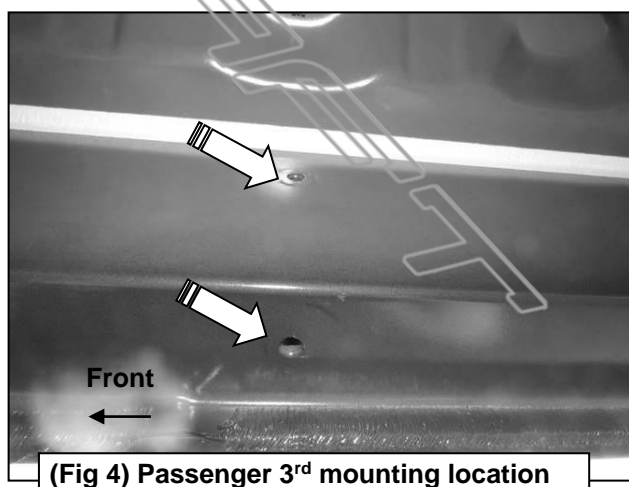

**(Fig 4) Passenger 3<sup>rd</sup> mounting location**

### Passenger/right side Installation Pictured

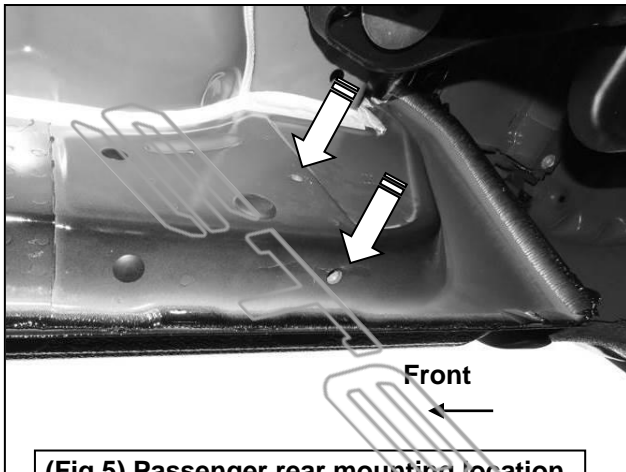

(Fig 5) Passenger rear mounting location

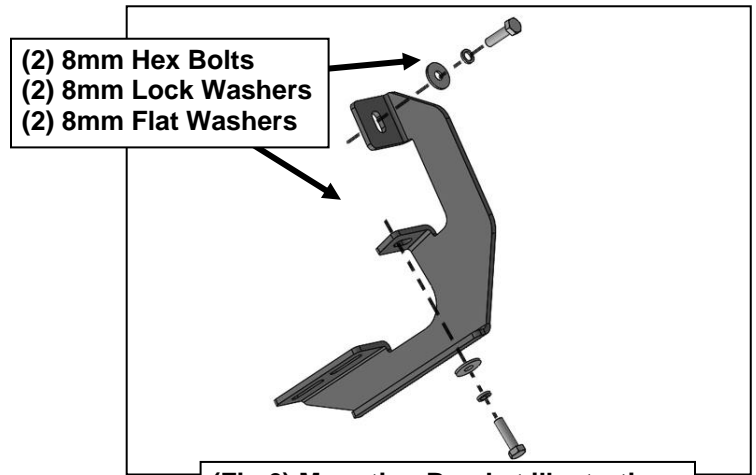

(Fig 6) Mounting Bracket illustration

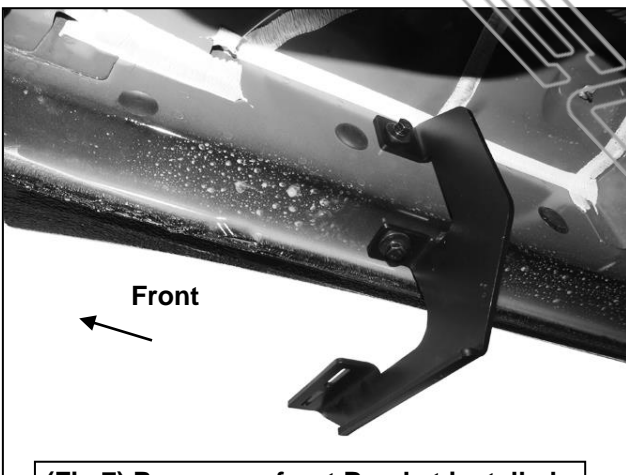

(Fig 7) Passenger front Bracket installed

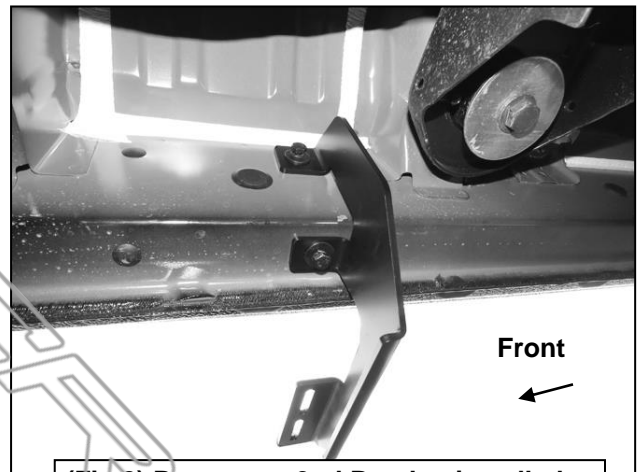

(Fig 8) Passenger 2nd Bracket installed

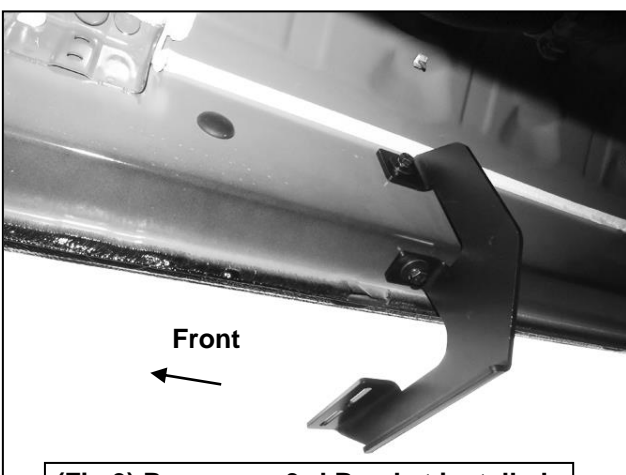

(Fig 9) Passenger 3rd Bracket installed

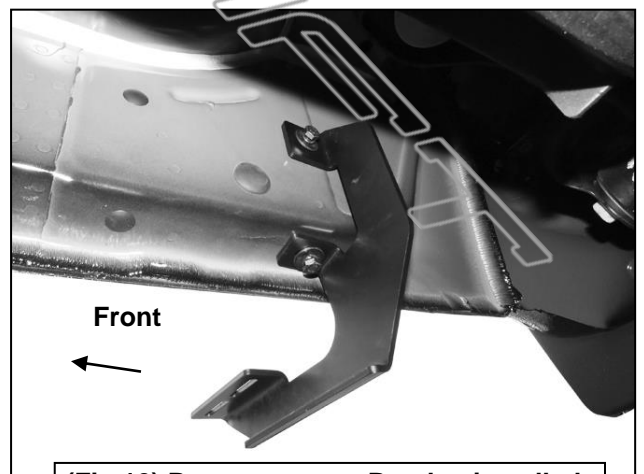

(Fig 10) Passenger rear Bracket installed

**Passenger/right side Installation Pictured**

