

# **INSTALLATION INSTRUCTIONS**

**3" BULL BAR**

**2007-17 CHEVY SILVERADO1500/GMC SIERRA1500**

**2007-15 TAHOE/SUBURBAN/YUKON/YUKON XL**

**2007-14 CADILLAC ESCALADE 1500/ESV/EXT**

**2007-13 CHEVY AVALANCHE**

STEEL DEFLECT

**PARTS LIST:**

1	Bull Bar	6	12mm x 24mm OD x 2.5mm Flat Washer
1	Driver/Left Mounting Bracket	6	12-1.75mm Nylon Lock Nut
1	Passenger/Right Mounting Bracket	4	10-1.50mm x 30mm Hex Bolt
2	12-1.75mm x 30mm Double Bolt Plate	8	10mm x 27mm OD x 3mm Flat Washer
2	12-1.75mm x 35mm Single Bolt Plate	4	10-1.50mm Nylon Lock Nut

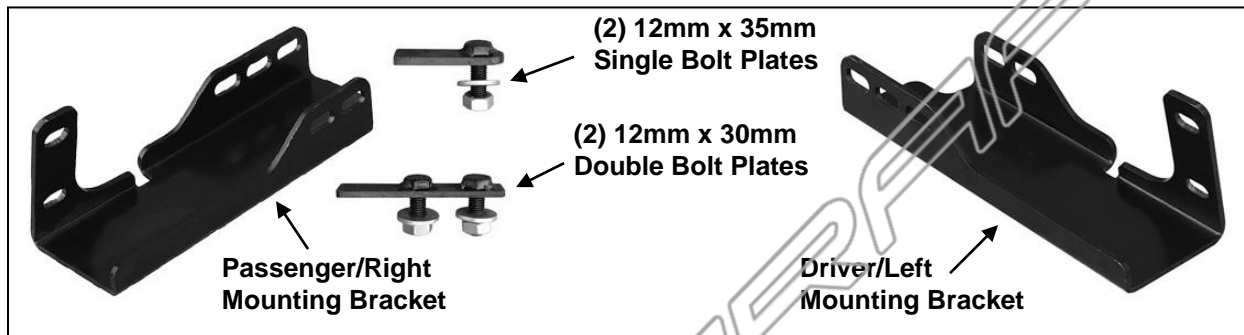

**PROCEDURE:**

**REMOVE CONTENTS FROM BOX AND VERIFY ALL PARTS ARE PRESENT. READ INSTRUCTIONS CAREFULLY. CUTTING MAY BE REQUIRED. INSTALLATION MAY INTERFERE WITH FRONT MOUNTED SENSORS. NOTE:** It may be necessary to remove/relocate front license plate and license plate bracket. It is not required, but strongly recommended. If local/state law requires a front license plate, license plate relocation kit is available.

1. Start installation from under the front of the vehicle. Determine if the vehicle is equipped with tow hooks. **IMPORTANT:** Tow hooks cannot be reinstalled with the Bull Bar.

**Tow Hook equipped vehicles:**

- a. Remove the factory tow hook from the end of each frame channel, **(Figure 1)**. Skip to **Step 2** if tow hooks were accessible and have been removed. **NOTE:** The driver side tow hook on some later models may be difficult to remove and assistance is highly recommended on these models. The following info only applies to the later GM models.
  - i. **Tow hook removal-option 1:** Remove the hex bolts securing the driver side of the bumper to the bracket. Use a short pry bar or large screwdriver to move the tab on the bumper bracket up and away to clear the hex bolt and slide it out past the bumper bracket, **(Figures 2A, 2B)**.
  - ii. **Option 2:** Remove plastic radiator grille. Loosen and/or completely remove the front bumper to remove the long hex bolt in the driver side tow hook, **(Figure 2B)**.
- b. Reattach the bumper after both tow hooks have been removed and the openings have been checked for Bracket clearance. Tighten all factory bumper hardware at this time.
- c. Proceed to **Step 2**.

**Vehicles without tow hooks:**

- a. Cut out the indented area in both sides of the plastic bumper insert to clear the Brackets as pictured, **(Figures 3 & 4)**. **IMPORTANT:** Make several small cuts for best fit. Do not cut through the top edge of the panel. **NOTE:** On some later models, the plastic panel is held in place with several small screws. The screws at the top corners are difficult to impossible to reach and remove without damaging the cover with the bumper in place. If you prefer to remove the panel to cut out the openings, it may be necessary or easier to remove the plastic grille then the steel bumper assembly with the plastic panel attached to access all of the small screws and clips.
- b. Reattach the bumper and/or bumper insert, (if removed), and grille once openings have been cut out and checked for clearance. Tighten all factory bumper hardware at this time.

2. Select the driver side Mounting Bracket. Insert the Bracket through the opening in the bumper, **(Figure 5)**. Trim the plastic as required to clear the Brackets.
3. Line up the holes in the Bracket with the holes in the end of the frame channel for the tow hook. Select (1) 12mm Double Bolt Plate, **(Figure 6A)**. Insert the Bolt Plate into the end of the frame, through the (2) holes in the side of the frame and out through the Bracket, **(Figures 5, 6B & 6C)**. Secure the Bracket to the Bolt Plate with (2) 12mm Flat Washers and (2) 12mm Nylon Lock Nuts, **(Figure 6C)**. Snug but do not fully tighten hardware at this time.
4. Repeat **Step 3** to install the 12mm x 35mm Single Bolt Plate, **(Figure 7A)**, into the remaining hole in the other side of the frame channel and Bracket, **(Figures 5, 7B & 7C)**.
5. **IMPORTANT:** The Brackets are designed with (2) mounting positions to fit multiple models and model years. Most Silverado/Sierra models will use the "back" mounting position with the Brackets pushed in to install the Bull Bar closer to the bumper, **(Figure 8A)**. Tahoe, Yukon and Suburban models may require the forward mounting position to move the Bull Bar forward or to provide more clearance for accessory lights, **(Figure 8B)**.
6. Repeat **Steps 2—5** to install the passenger side Mounting Bracket.
7. With assistance, hold the Bull Bar up in position on the outside of the Mounting Brackets. Bolt the Bull Bar to the Brackets with (4) 10mm x 30mm Hex Bolts, (8) 10mm Flat Washers and (4) 10mm Nylon Lock Nuts, **(Figure 9)**. Do not tighten hardware at this time.
8. Check the Bull Bar alignment with the vehicle and for clearance between the Bull Bar and the bumper. If Bull Bar is too close to or touching bumper, remove the Bull Bar and reinstall the Brackets in the "forward" position away from the bumper. Adjust as required then fully tighten all hardware at this time.
9. Do periodic inspections to the installation to make sure that all hardware is secure and tight.

**To protect your investment**, wax this product after installing. Regular waxing is recommended to add a protective layer over the finish. Do not use any type of polish or wax that may contain abrasives that could damage the finish.

**For stainless steel:** Aluminum polish may be used to polish small scratches and scuffs on the finish. Mild soap may be used also to clean the Bull Bar.

**For gloss black finishes:** Mild soap may be used to clean the Bull Bar.

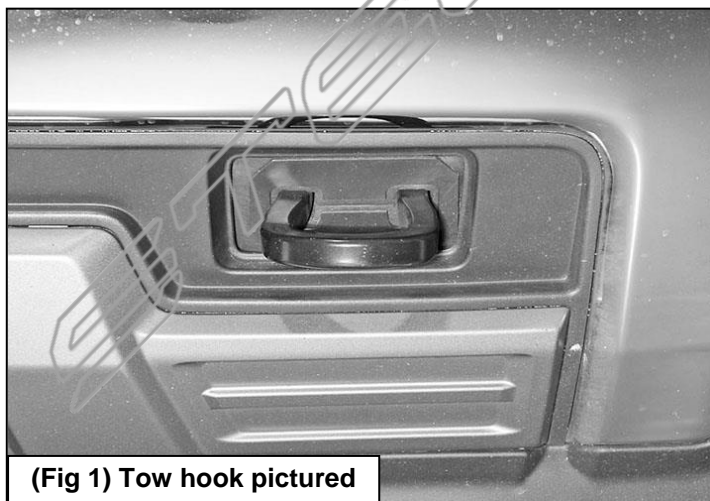

**(Fig 1) Tow hook pictured**

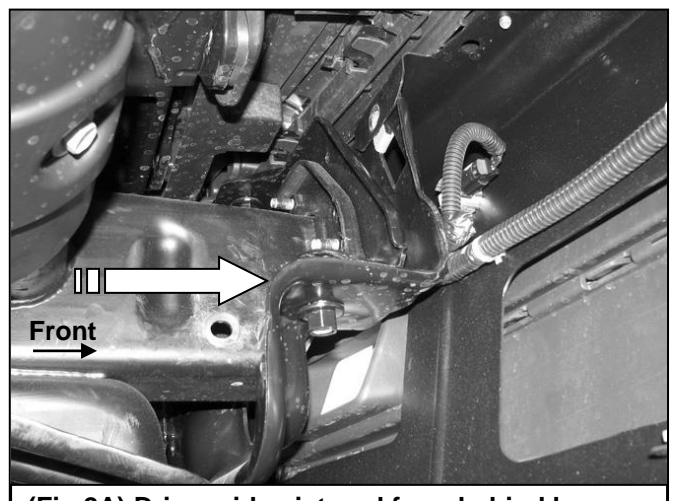

**(Fig 2A) Driver side pictured from behind bumper**

**Remove the bolts securing the driver side of the bumper to the bumper bracket. Use a large screwdriver or pry bar to move the mounting tab up enough to get the long bolt through the tow hook out of the end of the frame**

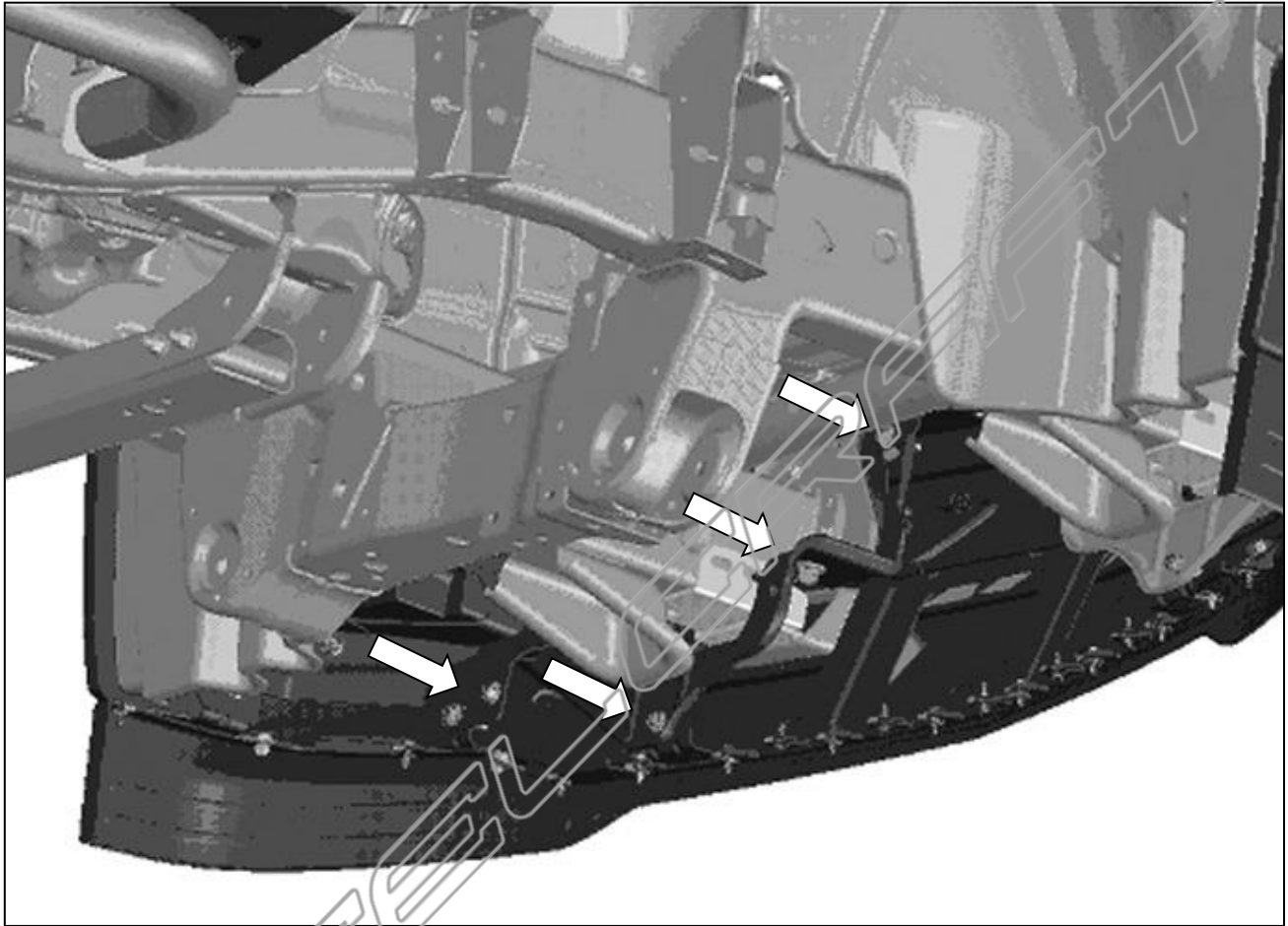

(Fig 2B) 2014 Silverado driver side illustrated from behind bumper to show bumper bolt locations.

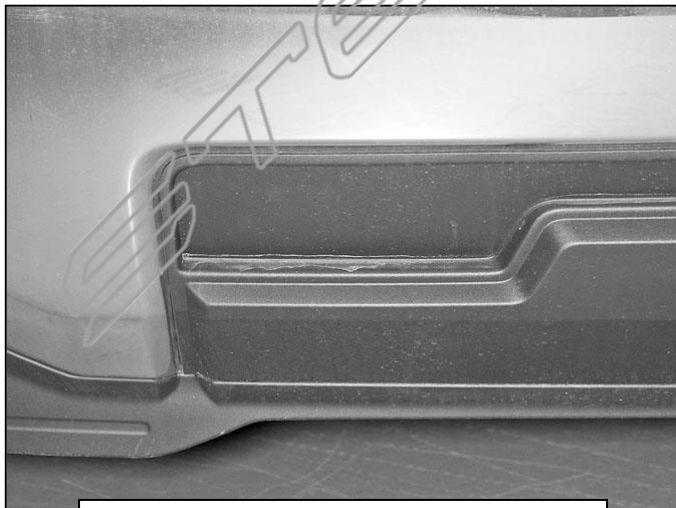

(Fig 3) Example of "no tow hook" model

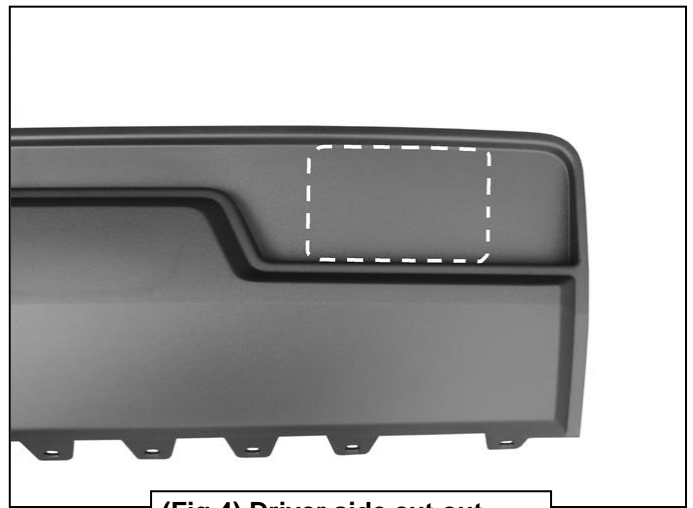

(Fig 4) Driver side cut out illustrated for reference only

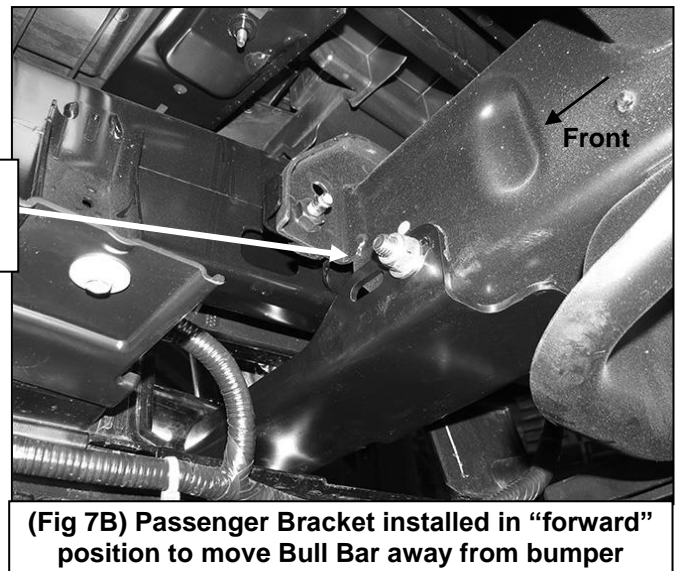
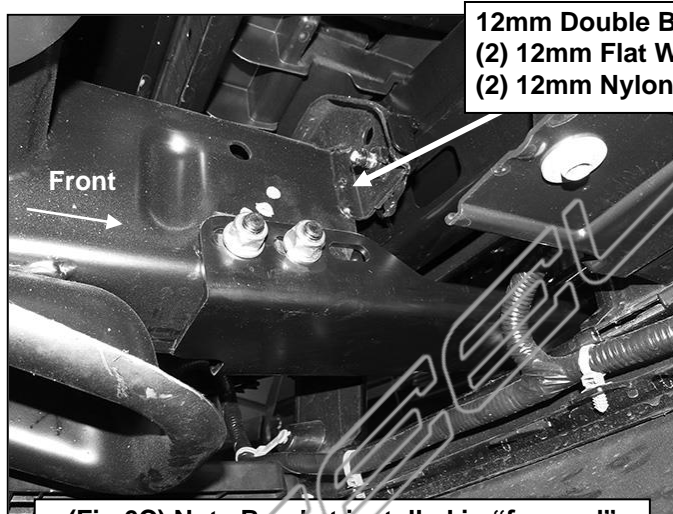
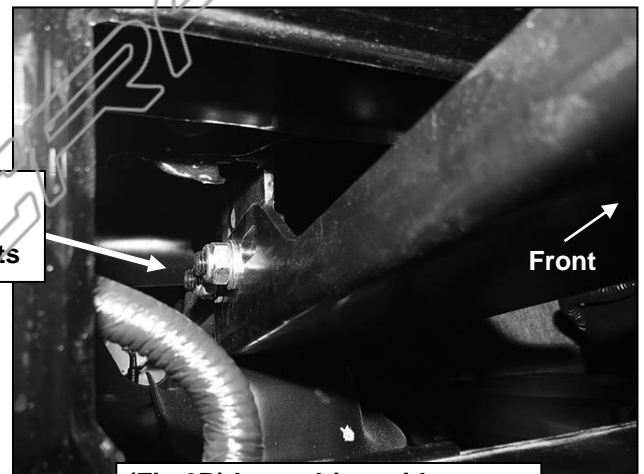
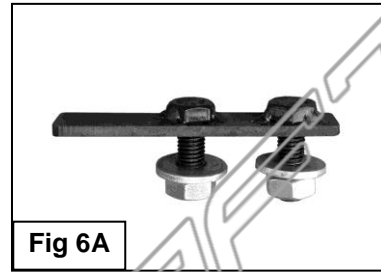
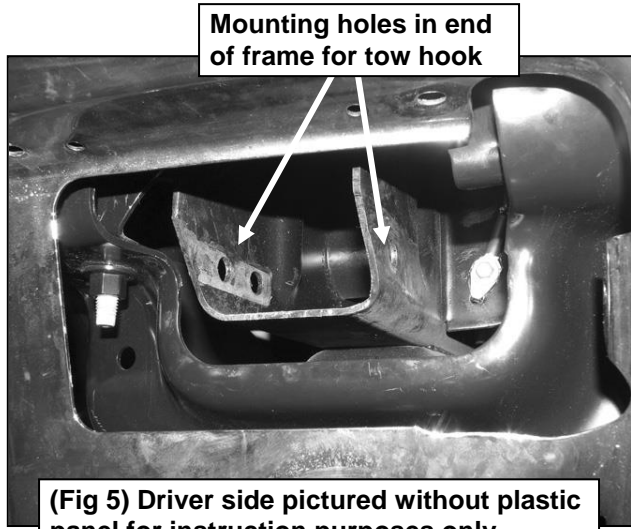

**Driver Side Mounting Bracket Installation Pictured**

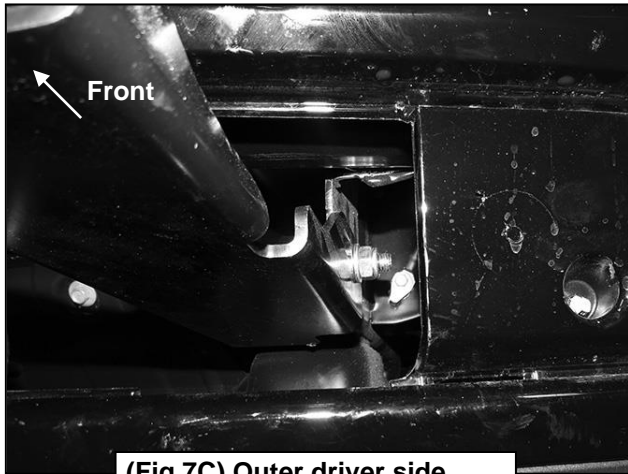

**(Fig 7C) Outer driver side Bracket with Single Bolt Plate**

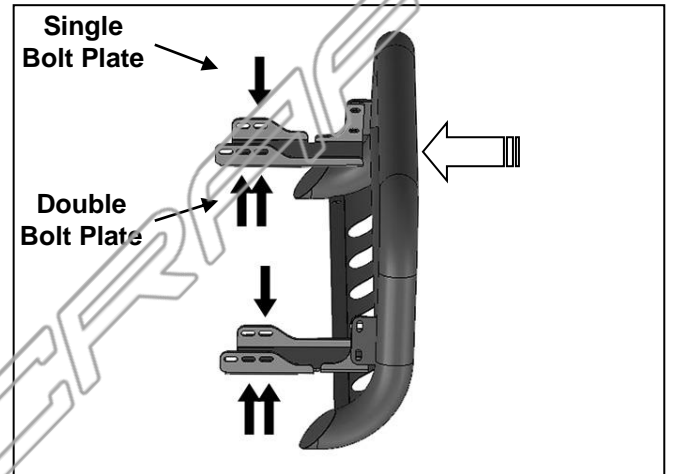

**(Fig 8A) Typical Silverado/Sierra mounting position**

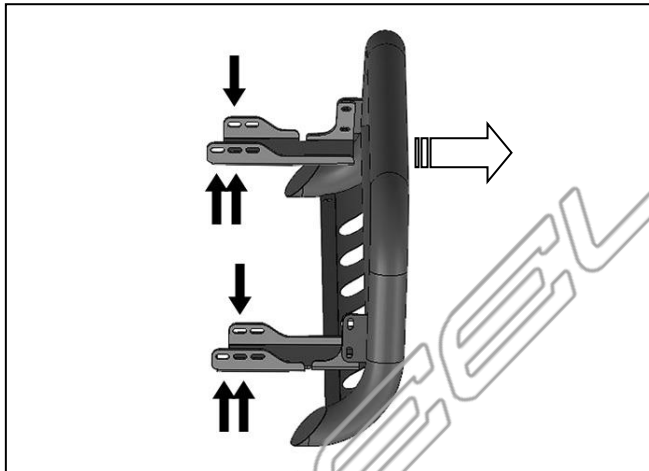

**(Fig 8B) Typical Tahoe/Yukon and Suburban mounting position**

- (2) 10mm x 30mm Hex Bolts
- (4) 10mm Flat Washers
- (2) 10mm Nylon Lock Nuts

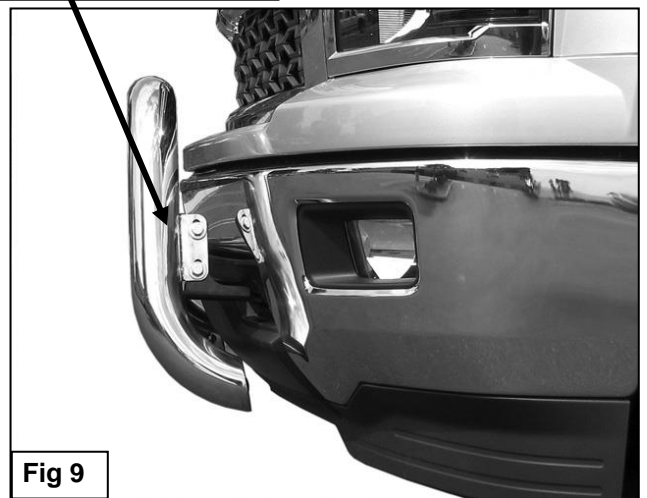

**Fig 9**



**Complete Installation**