

PARTS LIST:

1	Bull Bar	2	12mm Hex Nuts
1	Driver/Left Frame Mounting Bracket	4	10-1.5mm x 35mm Hex Bolts
1	Passenger/Right Frame Mounting Bracket	8	10mm x 27mm OD x 3mm Flat Washers
1	Driver/Left Mounting Bracket	4	10mm Lock Washers
1	Passenger/Right Mounting Bracket	4	10mm Hex Nuts
2	12-1.75mm x 110mm Hex Bolts	4	8-1.25mm x 25mm Special Self Tapping Flange Bolts
2	12-1.75mm x 50mm Hex Bolts	2	8-1.25mm x 55mm Double Sided Studs W/Nut
2	12mm x 44mm OD x 4mm Large Flat Washers	4	8mm x 24mm OD x 2mm Flat Washers
4	12mm x 32mm OD x 3mm STD Flat Washers	4	8mm Lock Washers
4	12mm Lock Washers	2	8mm Hex Nuts

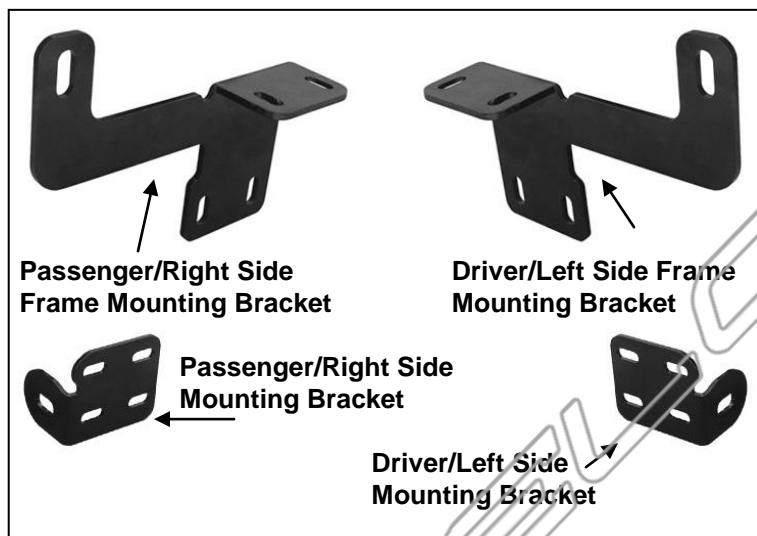

PROCEDURE:

REMOVE CONTENTS FROM BOX. VERIFY ALL PARTS ARE PRESENT. READ INSTRUCTIONS CAREFULLY BEFORE STARTING INSTALLATION. FACTORY SKID PLATE MUST BE REMOVED OR MODIFIED FOR INSTALLATION. NOTE: It may be necessary to remove/relocate front license plate and license plate bracket. It is not required, but strongly recommended. If local/state law requires a license plate, license plate relocation kit is available.

1. Start the installation on the driver side, front of the vehicle. If vehicle is equipped with a plastic air box, remove the airbox, **(Figure 1)**. Select the driver side Frame Mounting Bracket. Hold the Bracket in position against the outside of the frame channel. Insert (1) 12mm x 110mm Hex Bolt with (1) 12mm x 32mm Flat Washer sideways through the Mounting Bracket and frame, **(Figure 2)**. Thread (1) 12mm x 44mm Large Flat Washer, (1) 12mm Lock Washer and (1) 12mm Hex Nut onto the end of the 12mm x 110mm Hex Bolt, **(Figure 3)**. Do not tighten hardware at this time.
2. Line up the (2) slots in the bottom of the Bracket with the (2) factory holes in the bottom of the frame.
 - a. **1998-2009 vehicles without plastic airbox:** Slowly thread (2) 8mm x 25mm Self Tapping Flange Bolts into the factory holes in the frame, **(Figure 4)**. Do not tighten hardware at this time. Repeat this Step for passenger side Frame Bracket installation. **IMPORTANT!** Do not over-tighten the Bracket hardware or damage to the frame may result.
 - b. **2010-11 vehicles with plastic airbox or factory skid plate (must be removed):** The forward hole is not threaded; the rear hole is threaded for a hex bolt and was used to hold the air box or skid plate in place. Slowly thread the (1) 8mm x 25mm Self Tapping Flange Bolt into the forward unthreaded hole in the frame, **(Figure 5A)**. Do not tighten hardware. Thread (1) 8-1.25mm x 50mm Double Sided Stud with (1) 8mm Flat Washer and (1) 8mm Lock Washer into the rear threaded hole, **(Figure 5A & 5B)**. **NOTE:** Installation of the 8mm Double Sided Stud will require

**BULL BAR
1998-2011 FORD RANGER**

a long reach deep socket. Snug but do not tighten hardware at this time. Repeat this Step for passenger side Frame Mounting bracket installation. **IMPORTANT!** Do not over-tighten the Mounting Bracket hardware or damage to the frame may result.

3. Next, determine the correct mounting position for the driver side Bull Bar Mounting Bracket:
 - a. **98-09 models:** Use the higher installed position to raise the Bull Bar, (**See Figure 6A**).
 - b. **2010-11 models:** Use the lower installed position to clear the factory spoiler, (**See Figure 6B**).
4. Bolt the driver side Mounting Bracket to the outside of the Frame Mounting Bracket with the included (2) 10mm x 35mm Hex Bolts, (4) 10mm Flat Washers, (2) 10mm Lock Washers and (2) 10mm Hex Nuts, (**Figure 6A or 6B**). Do not tighten hardware at this time. Repeat this Step for passenger side Bracket installation.
5. With help position the Bull Bar up to the Mounting Brackets. Use the included (2) 12mm x 50mm Hex Bolts, (2) 12mm Lock Washers and (2) 12mm Flat Washers to attach the Bull Bar to the Mounting Brackets, (**Figure 7**). Snug but do not tighten hardware at this time.
6. Adjust the Bull Bar properly and tighten all hardware. **IMPORTANT!** Do not over-tighten the Mounting Bracket hardware or damage to the frame may result.
7. **On vehicles with plastic airbox removed in Step 1:** Remove the (2) plastic clips from the plastic air box, (**Figure 8**). Hold the airbox up to the vehicle. Insert the plastic clips into the forward previously unused holes if there are corresponding holes in the bottom of the frame. If there are no holes in the frame, discard the plastic clips. Place the air box in position over the 8mm Double Sided Stud on the driver side. Secure the air box to the 8mm Double Sided Stud with (1) 8mm Flat Washer, (1) 8mm Lock Washer and (1) 8mm Hex Nut, (**Figure 9**). Bolt the front of the airbox to the frame rail with the factory hex bolt and the plastic clip-if used, (**Figure 10**). Do not tighten hardware at this time. Repeat this step to attach the air box on the passenger side. Tighten all hardware.
8. Do periodic inspections to the installation to make sure that all hardware is secure and tight.

To protect your investment, wax this product after installing. Regular waxing is recommended to add a protective layer over the finish. Do not use any type of polish or wax that may contain abrasives that could damage the finish.

For stainless steel: Aluminum polish may be used to polish small scratches and scuffs on the finish. Mild soap may be used also to clean the Bull Bar.

For gloss black finishes: Mild soap may be used to clean the Bull Bar.

Driver Side Installation Pictured

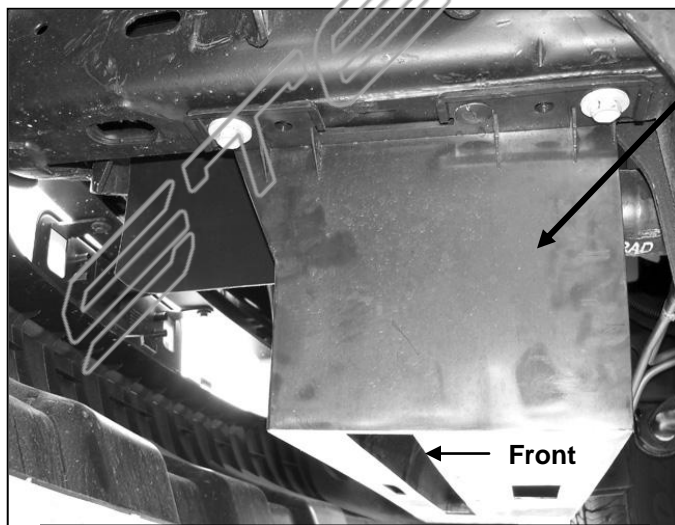

(Fig 1) Driver side mounting location pictured

Remove the factory plastic air box-if equipped

**12mm x 110mm Hex Bolt
12mm x 32mm STD Flat Washer**

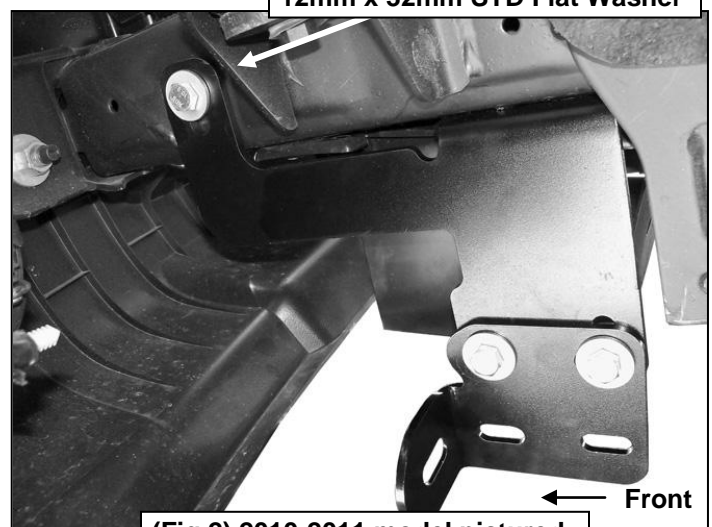

(Fig 2) 2010-2011 model pictured

Driver Side Installation Pictured

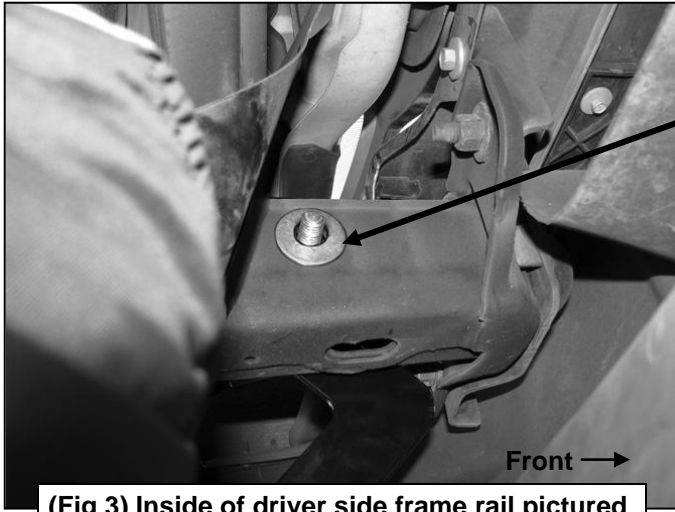

(Fig 3) Inside of driver side frame rail pictured

- 12mm x 44mm Large Flat Washer
- 12mm Lock Washer
- 12mm Hex Nut (not pictured)

(2) 8mm Self Tapping Flange Bolts

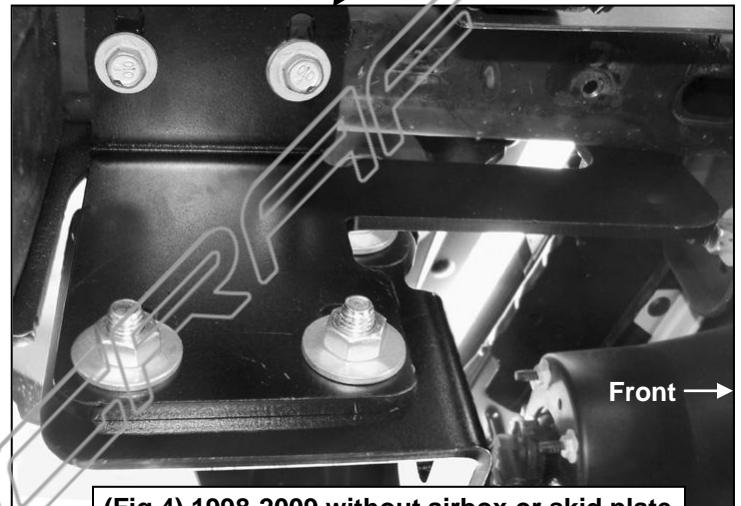

(Fig 4) 1998-2009 without airbox or skid plate

- 8mm x 50mm Double Sided Stud
- 8mm Flat Washer
- 8mm Lock Washer

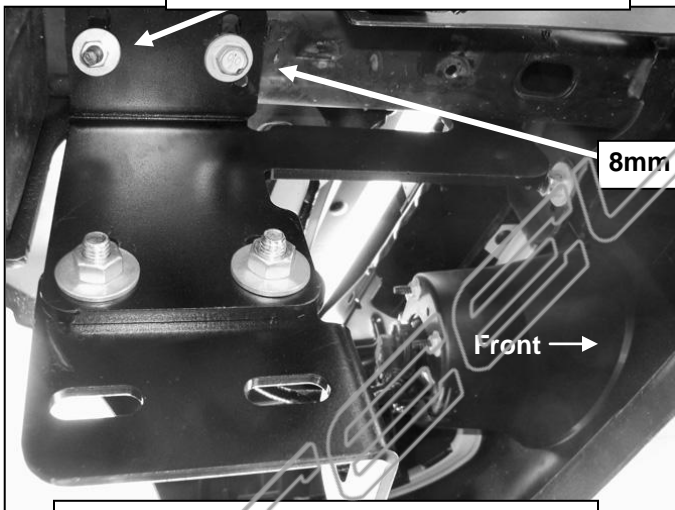

(Fig 5A) 2010-11 with airbox or skid plate

8mm Self Tapping Flange Bolt



(Fig 5B) 8mm x 50mm Double Sided Stud

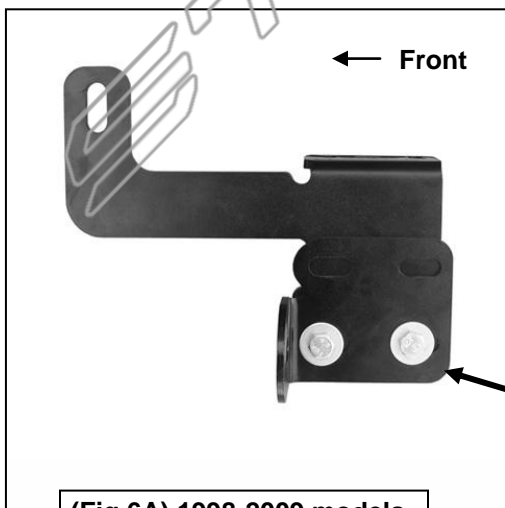

(Fig 6A) 1998-2009 models

- 10mm x 35mm Hex Bolts
- 10mm Flat Washers
- 10mm Lock Washers
- 10mm Hex Nuts

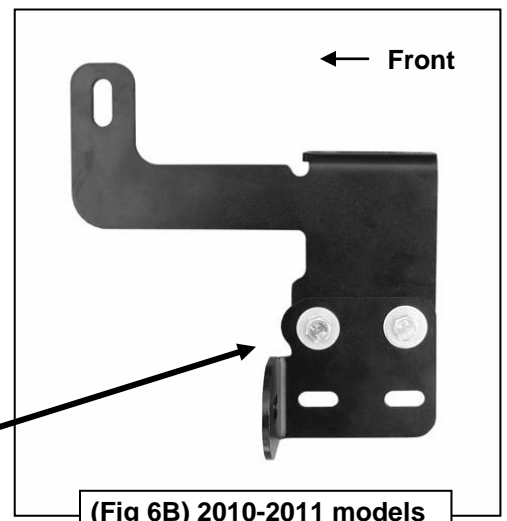

(Fig 6B) 2010-2011 models

Driver Side Installation Pictured

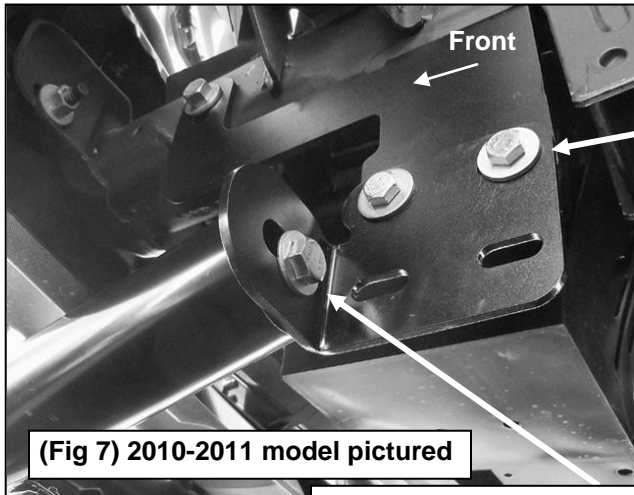

(Fig 7) 2010-2011 model pictured

**12mm x 50mm Hex Bolt
12mm x 32mm STD Flat Washer
12mm Lock Washer**

**8mm x 50mm Double Sided Stud
8mm Flat Washer
8mm Lock Washer
8mm Hex Nut**

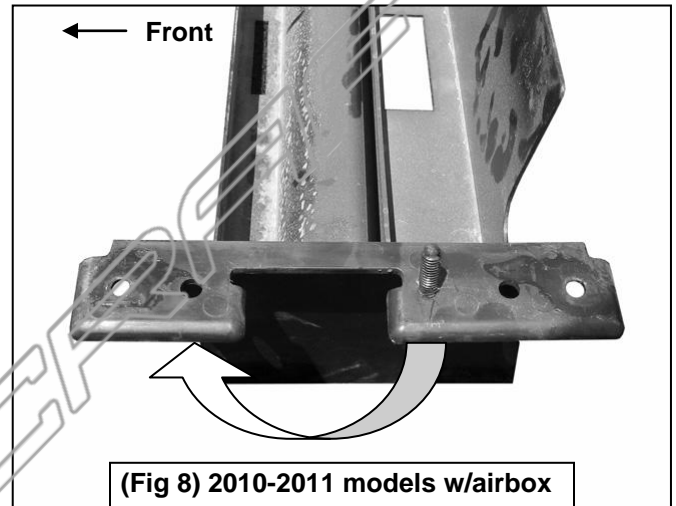

(Fig 8) 2010-2011 models w/airbox

Relocate factory plastic fastener from this hole to this one on air box if bottom of frame is equipped from factory with hole in this position, (See Fig 10)

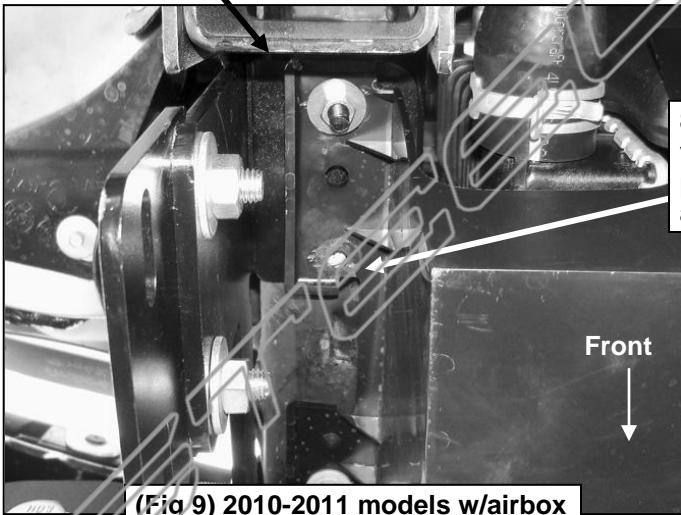

(Fig 9) 2010-2011 models w/airbox

Factory plastic fastener (or discard fastener if there is no hole in frame as pictured)

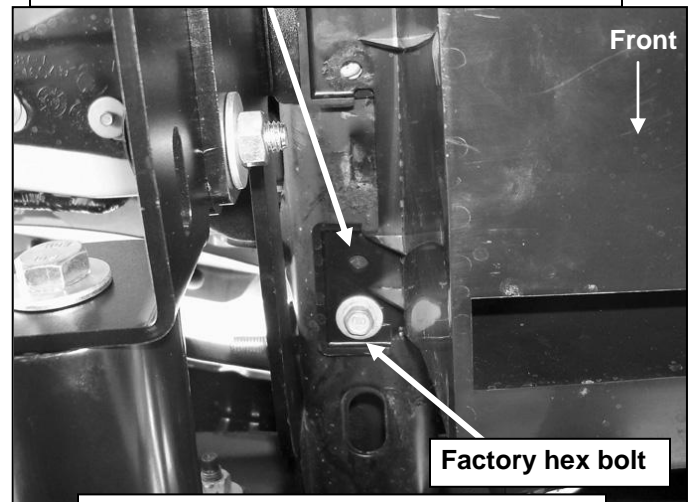

(Fig 10) 2010-11 models w/airbox driver side pictured from below vehicle