

PARTS LIST:

1	Driver/Left Side Bar	12	8-1.25mm x 30mm Hex Bolts
1	Passenger/Right Side Bar	24	8 x 24mm OD x 2mm Flat Washers
3	Left Offset Mounting Brackets	24	8mm Lock Washers
3	Right Offset Mounting Bracket	12	8-1.25mm Hex Nuts

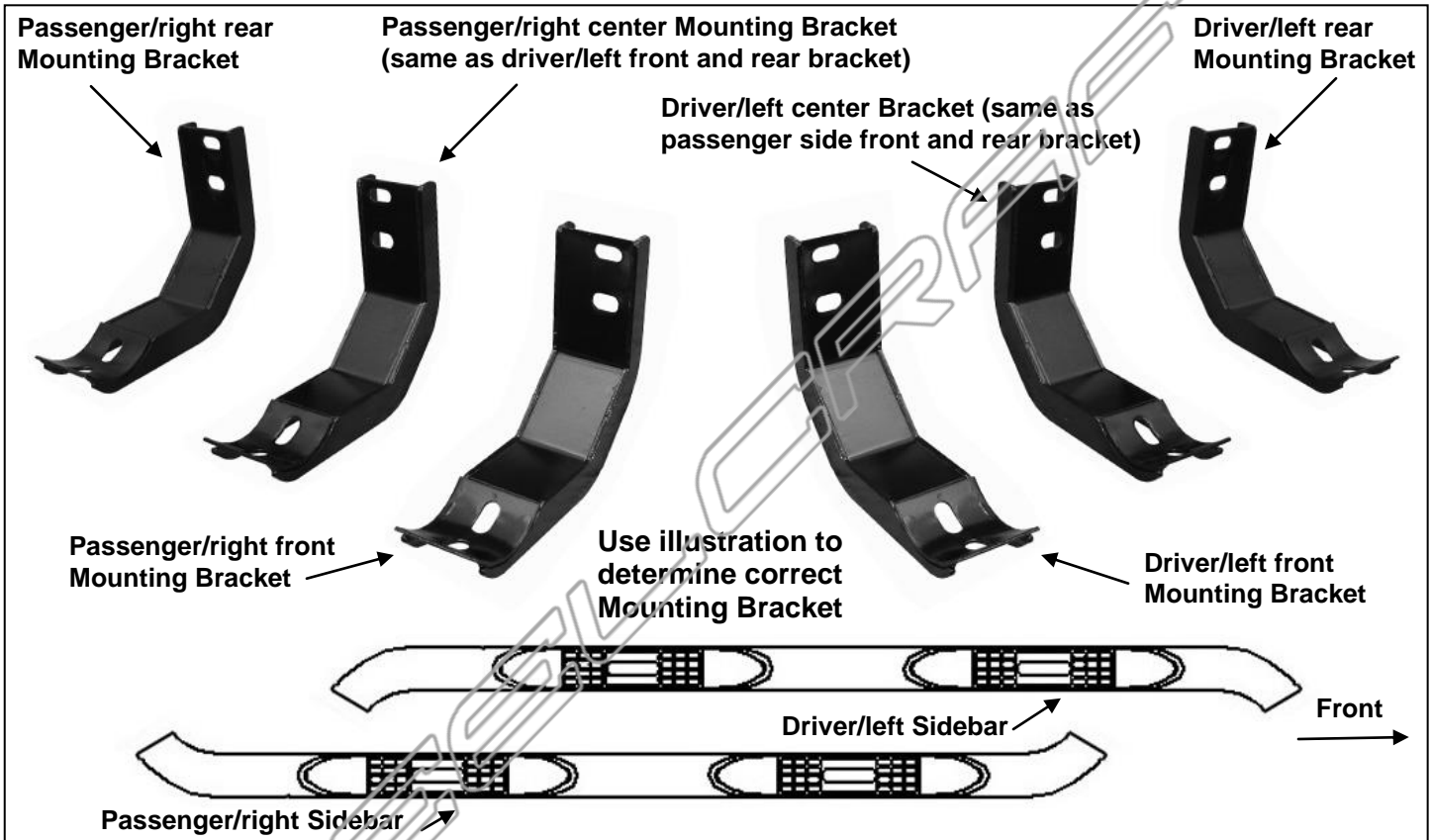

PROCEDURE:

1. REMOVE CONTENTS FROM BOX. VERIFY ALL PARTS ARE PRESENT. READ INSTRUCTIONS CAREFULLY.
2. Remove the existing factory running boards or side steps if equipped. Place Brackets on the ground in the order as pictured above.
3. Select the driver side front Mounting Bracket, **(Figure 1A)**. Attach the Bracket to the threaded studs at the front mounting location, **(Figure 1B)**, with the included (2) 8mm Flat Washers, (2) 8mm Lock Washers and (2) 8mm Hex Nuts. Do not tighten at this time. **IMPORTANT:** Top mounting holes in Brackets are off set toward the front or back, **(Figures 1A and 2A)**. Use the illustrations to select the proper Mounting Bracket.
4. Repeat **Step 3** for the driver side center, **(Figures 2A and 2B)**, and rear Mounting Bracket installation, **(Figures 3A & 3B)**. **IMPORTANT:** Use the illustrations to select the proper Mounting Bracket for all locations.
5. Carefully place the driver Sidebar onto the Mounting Brackets. Bolt the Sidebar to the Brackets with the included (6) 8mm Hex Bolts, (6) 8mm Lock Washers and (6) 8mm Flat Washers, **(Figure 3B)**. Snug hardware but do not tighten.
6. Level and adjust the Sidebars as desired and tighten all hardware.

7. Repeat **Steps 2 - 6** for passenger Sidebar installation.
8. Do periodic inspections to the installation to make sure that all hardware is secure and tight.

**To protect your investment**, wax this product after installing. Regular waxing is recommended to add a protective layer over the finish. Do not use any type of polish or wax that may contain abrasives that could damage the finish.

**For stainless steel:** Aluminum polish may be used to polish small scratches and scuffs on the finish. Mild soap may be used also to clean the Sidebar.

**For gloss black finishes:** Mild soap may be used to clean the Sidebar.

### Driver Side Installation Pictured

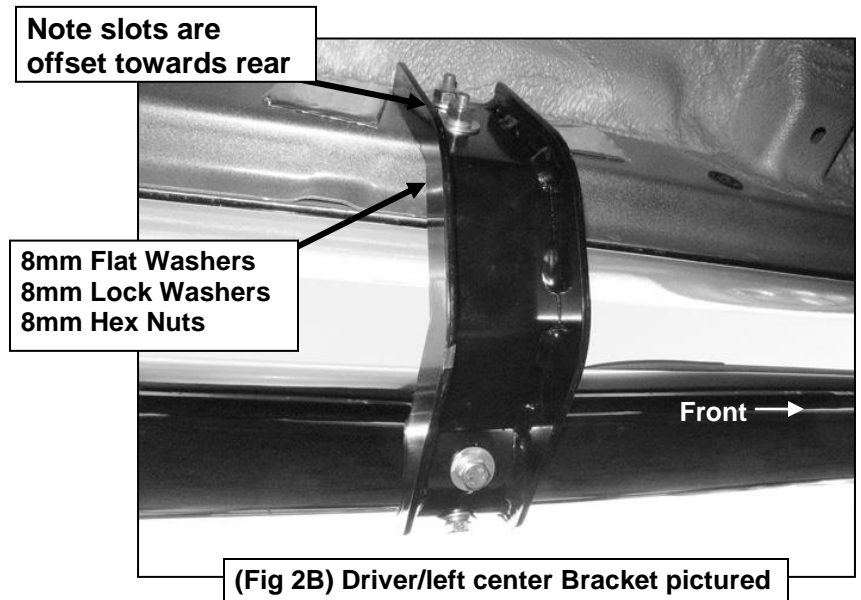
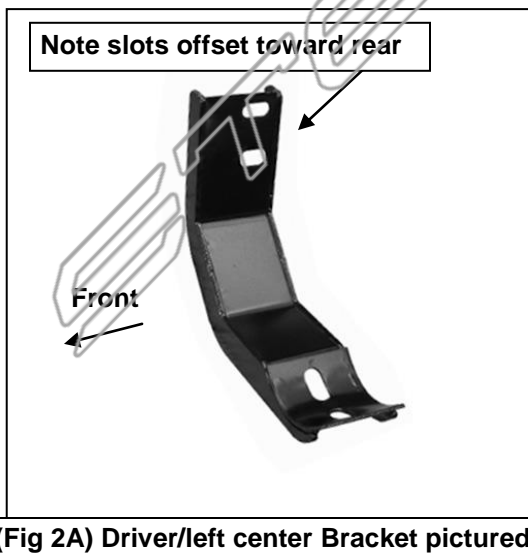
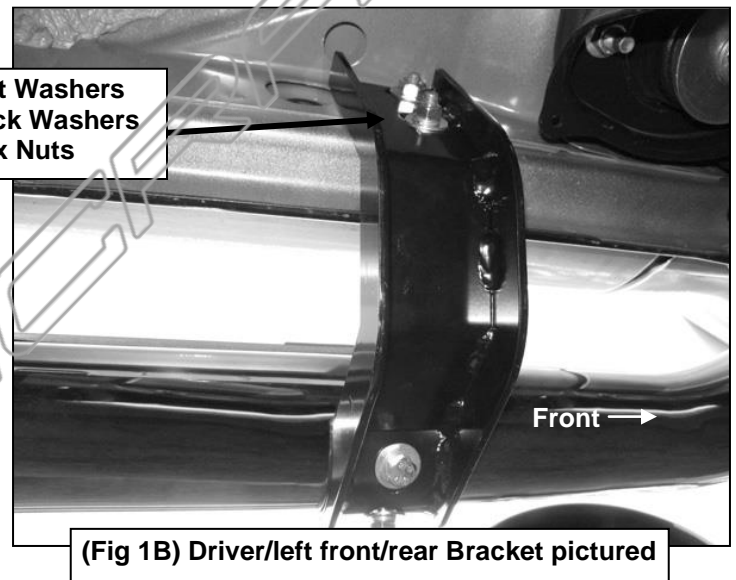
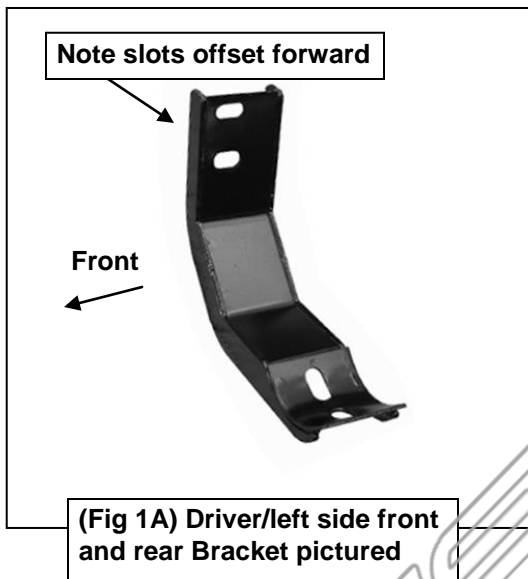

**3" SIDE BAR  
05-14 NISSAN FRONTIER CREW CAB**

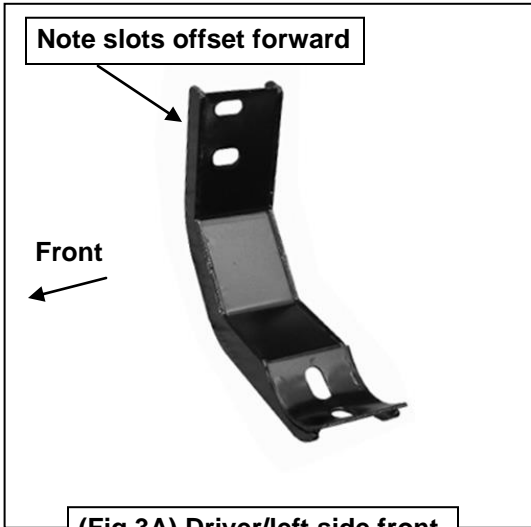

**(Fig 3A) Driver/left side front and rear Bracket pictured**

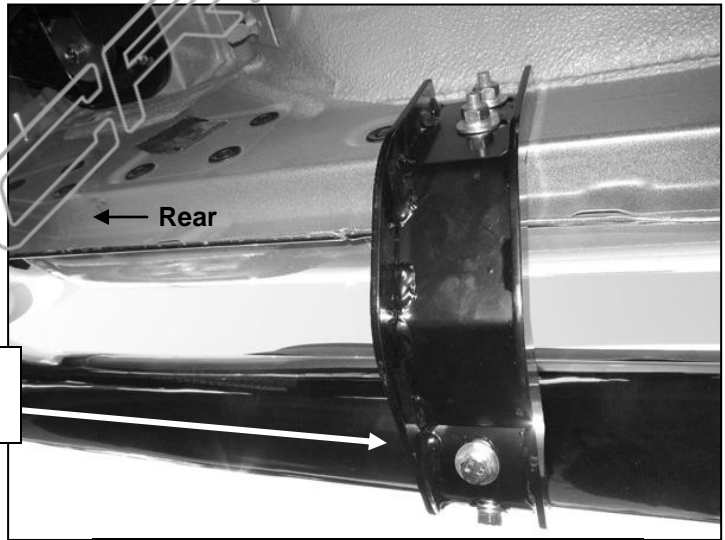

**(Fig 3B) Driver/left rear Bracket pictured**

- 8mm x 30mm Hex Bolts**
- 8mm Flat Washers**
- 8mm Lock Washers**



**Installation Complete**