

**IMPORTANT ALERT: GM uses a very strong thread-locking compound on all body bolts. Use of an air assisted impact ratchet can cause damage to the threads on factory body mount bolts and the internal nut assembly because of this thread locking compound.**

**We only recommend the use of hand tools to slowly remove and reinstall body mount bolts on all GM vehicles.**

**PROCEDURE:**

**CRITICAL INFORMATION: If during the removal process, it becomes increasingly difficult to unscrew the body mount bolt with hand tools, tighten the bolt several rotations to clear the thread locking compound from the threads, then reverse direction and continue to unscrew until the body mount bolt is out. Repeat this process as necessary on all GM body mount bolts. Use of an appropriate anti-seize compound is highly recommended for re-installation. Tighten body mount bolt to factory torque specifications for your particular model year.**

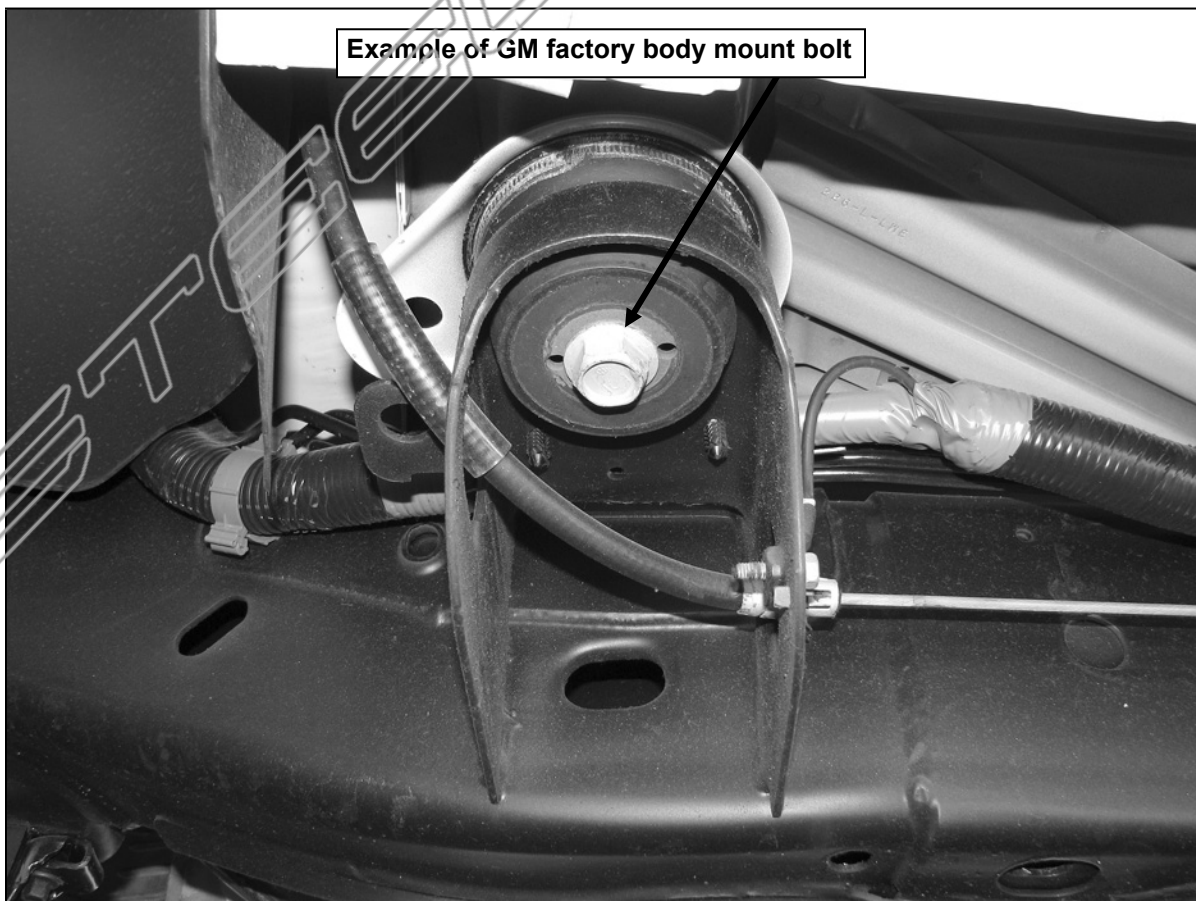

**PARTS LIST:**

Qty	Description	Qty	Description
1	Driver/Left Sidebar	2	10mm Nut Plates
1	Passenger/Right Sidebar	4	10-1.50mm x 30mm Hex Bolts
1	Driver/Left Front Mounting Bracket	6	10mm x 20mm OD x 2mm Flat Washers
1	Passenger/Right Front Mounting Bracket	4	10mm Lock Washers
1	Driver/Left Rear Mounting Bracket	2	10mm Hex Nuts
1	Passenger/Right Rear Mounting Bracket	8	8-1.25 x 25mm Hex Bolts
1	Driver/Left Front Support Bracket	8	8mm x 24mm x 2mm Flat Washers
1	Passenger/Right Front Support Bracket	8	8mm Lock Washers

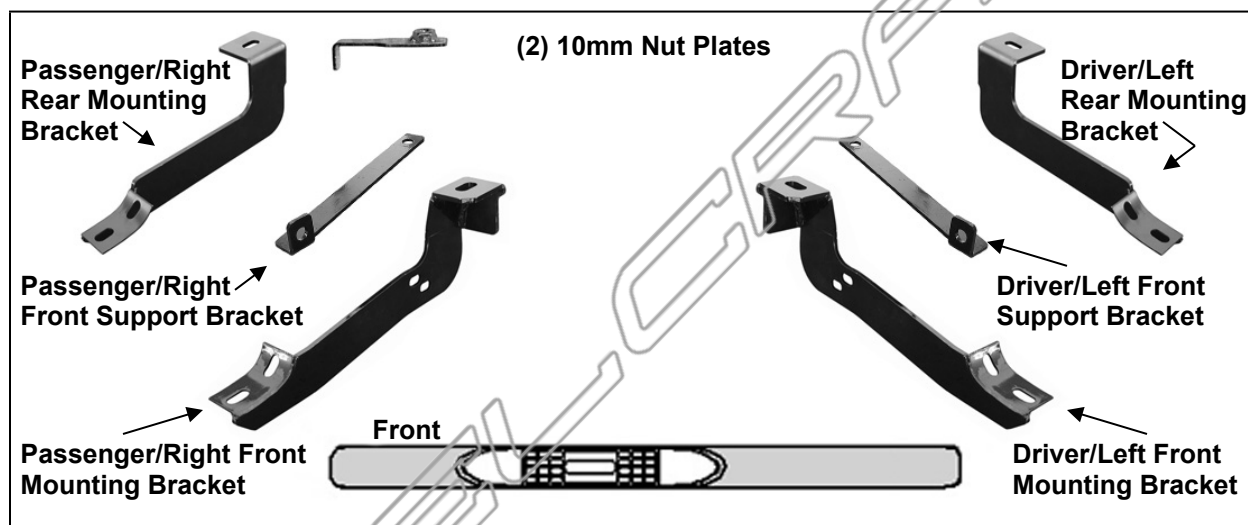

**PROCEDURE:**

**REMOVE CONTENTS FROM BOX. VERIFY ALL PARTS ARE PRESENT. READ FACTORY BODY BOLT REMOVAL INSTRUCTIONS AND INSTALLATION INSTRUCTIONS CAREFULLY BEFORE STARTING INSTALLATION.**

1. Start the installation under the driver side of the vehicle and remove the front and rear body mount bolts. Do not remove bushings.
2. Hang the driver side front and rear Mounting Brackets from the body mounts using the factory hex bolts, **(Figures 1 & 2)**. Do not tighten hardware at this time.
3. Locate the two factory holes in the bottom of the frame towards the front of the vehicle. Insert (1) 10mm Nut Plate, **(Figure 3A)**, into the oval hole and line up the threaded nut with the forward round hole, **(Figure 3B)**.
4. Attach the driver side front Support Bracket to the Nut Plate with (1) 10mm x 30mm Hex Bolt, (1) 10mm Lock Washer and (1) 10mm Flat Washer, **(Figures 4 & 5)**. Do not tighten hardware at this time.

**1500 Models:**

Attach the bent end of the Front Support Bracket to the outside hole in the Front Mounting Bracket with (1) 10mm x 30mm Hex Bolt, (2) 10mm Flat Washers, (1) 10mm Lock Washer and (1) 10mm Hex Nut, **(Figure 4)**. Do not tighten at this time.

**Up to 2010 25-3500 Models:**

Note that the Front Support Bracket will not reach up to the Mounting Bracket, **(Figure 5)**. Tighten the Support Bracket to the Nut Plate in the frame. Carefully push up on the Support Bracket until it reaches the lower/inside hole in the Mounting Bracket. Bolt the Support Bracket to the hole in the Mounting Bracket with (1) 10mm x 30mm Hex Bolt, (2) 10mm Flat Washers, (1) 10mm Lock Washer and (1) 10mm Hex Nut, **(Figure 4)**. Do not tighten at this time.

5. Carefully position the Driver Sidebar onto the Mounting Brackets. Attach the Sidebar to the Mounting Brackets with (4) 8mm x 25mm Hex Bolts, (4) 8mm Lock Washers and (4) 8mm Flat Washers, **(Figure 6)**. Do not tighten hardware at this time.
6. Level and adjust the Sidebar and tighten all hardware.
7. Repeat steps 2-6 for passenger Sidebar installation.
8. Do periodic inspections to the installation to make sure that all hardware is secure and tight.

**To protect your investment**, wax this product after installing. Regular waxing is recommended to add a protective layer over the finish. Do not use any type of polish or wax that may contain abrasives that could damage the finish.

**For stainless steel:** Aluminum polish may be used to polish small scratches and scuffs on the finish. Mild soap may be used also to clean the Sidebar.

**For gloss black finishes:** Mild soap may be used to clean the Sidebar.

### Driver Side Installation Pictured

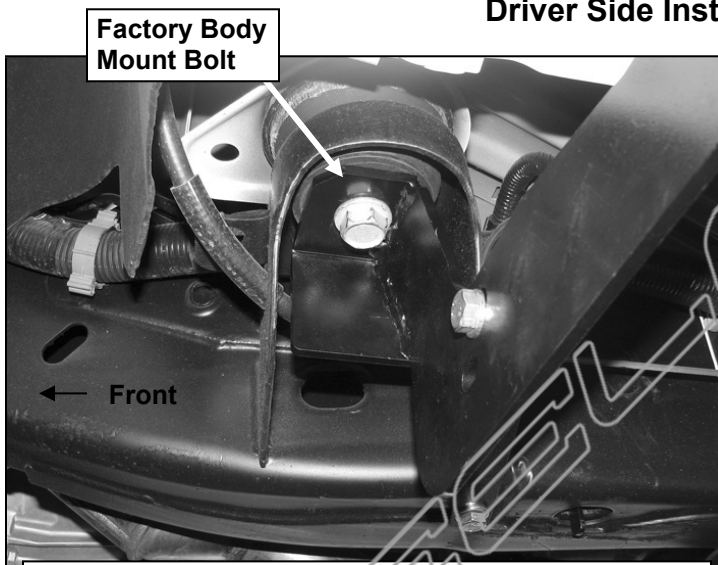

(Fig 1) Driver side front Mounting Bracket pictured

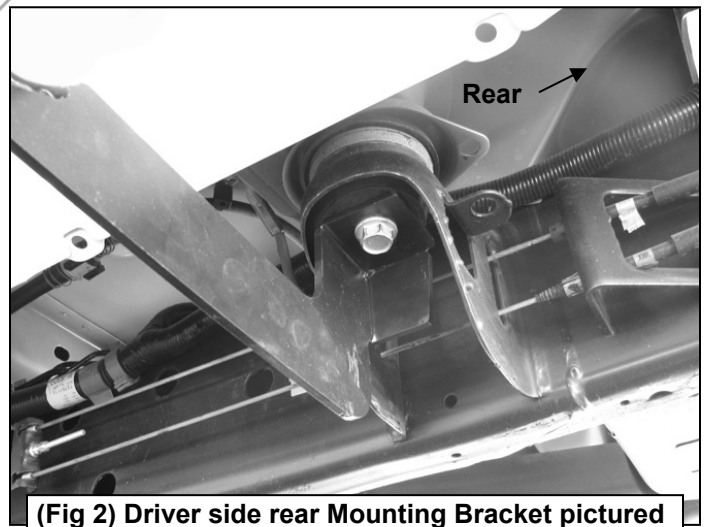

(Fig 2) Driver side rear Mounting Bracket pictured

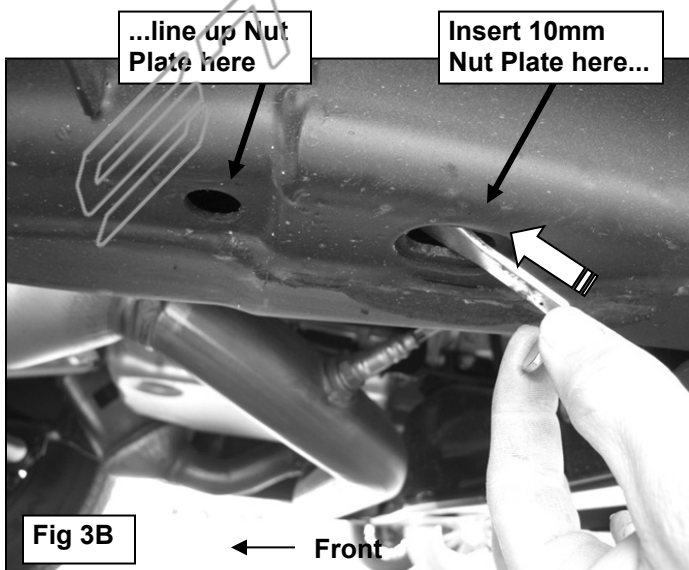

Fig 3B

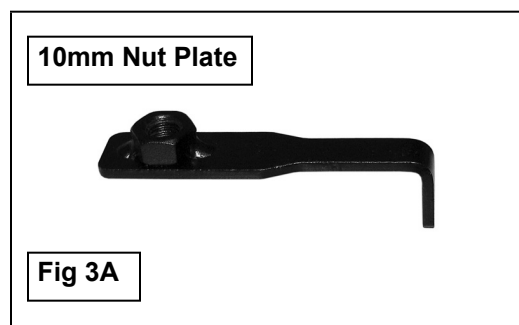
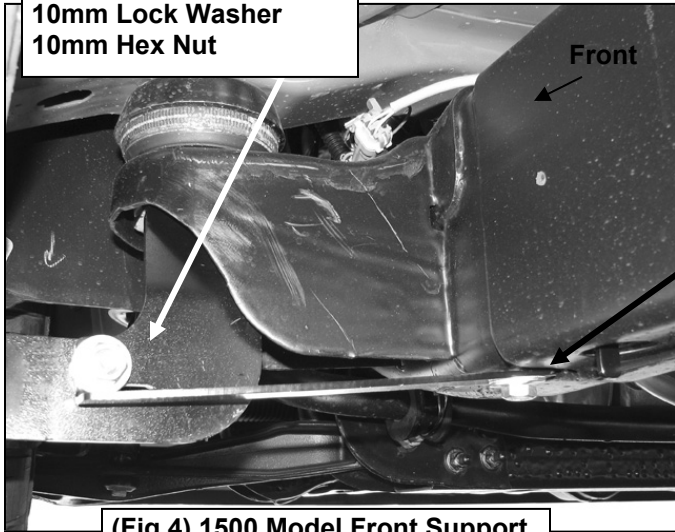

Fig 3A

### Driver Side Installation Pictured

10mm x 30mm Hex Bolt  
(2) 10mm Flat Washers  
10mm Lock Washer  
10mm Hex Nut



(Fig 4) 1500 Model Front Support Bracket Installation Pictured

10mm Nut Plate  
10mm x 30mm Hex Bolt  
10mm Lock Washer  
10mm Flat Washer

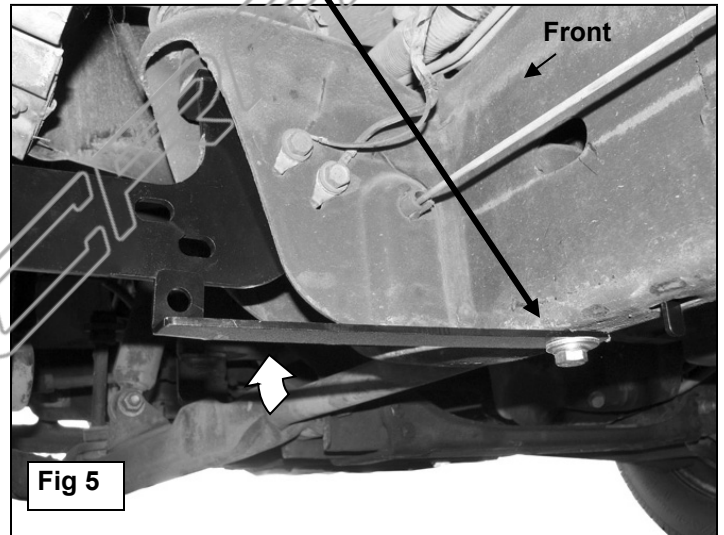
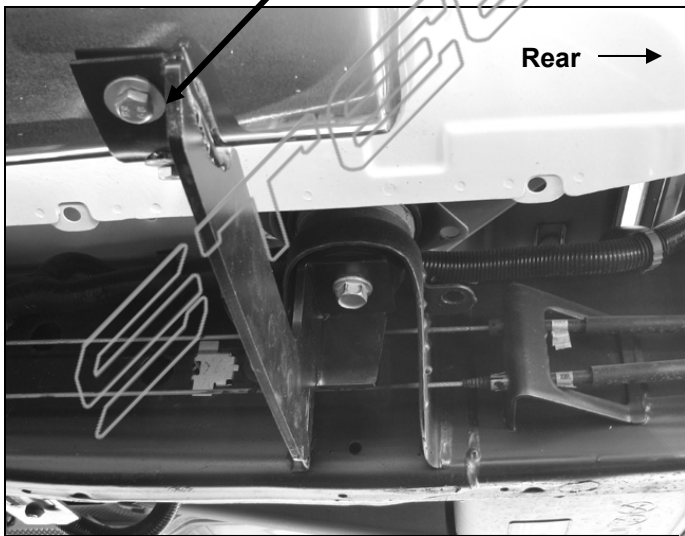

Fig 5

(2) 8mm x 25mm Hex Bolts  
(2) 8mm Lock Washers  
(2) 8mm Flat Washers



(Fig 6) Driver side rear Bracket installation pictured

**IMPORTANT NOTE:** Up to 2010 25-3500 Model Front Support Bracket Installation Pictured. Bend Support Bracket up by hand to meet the Front Mounting Bracket. Front Support Bracket not required for 2011-12 25-3500 models



Complete Installation